



Multiple Access Techniques:

- FDMA: Frequency Division Multiple Access
- TDMA: Time Division Multiple Access
- CDMA: Code Division Multiple Access



Atlanta RF

Services, Software & Designs

Presentation Content

Multiple Access Techniques: FDMA, TDMA & CDMA

1. Shared Resources: Time & Frequency.
2. Duplexing Methods:
 - A. Overview: FDD & TDD.
 - B. FDD: Frequency Division Duplex.
 - C. TDD: Time Division Duplex.
 - D. Compare: FDD & TDD.
3. Multiplexing & Multiple Access:
 - A. Multiplexing Principles.
 - B. Multiplexing in 4 dimensions.
 - C. FDM: Frequency Division Multiplexing.
 - D. TDM: Time Division Multiplexing.
 - E. Time & Frequency Division Muxing.
 - F. CDM: Code Division Multiplexing.
4. Multiple Access Techniques:
 - A. Types of Multiple Access Techniques.
 - B. Multiple Access' Design Importance.
5. FDMA: Frequency Division Multiple Access
 - A. Overview of FDMA.
 - B. Principle of Operation & Features.
 - C. Advantages & Disadvantages.
6. TDMA: Time Division Multiple Access
 - A. Overview & Principle of Operation.
 - B. TDMA in Satellites & 2G wireless.
 - C. TDMA Frame Structure & Channels.
 - D. TDMA/TDD and TDMA/FDD.
 - E. Advantages & Disadvantages.
7. CDMA: Code Division Multiple Access
 - A. Overview & Spread Spectrum.
 - B. CDMA Transmit & Receive.
 - C. DS-CDMA: Direct Sequence CDMA.
 - D. FH-CDMA: Frequency Hop CDMA.
 - E. Pilot Channel & Processing Gain.
 - F. Advantages & Disadvantages.
8. Hybrid Multiple Access Techniques.
 - A. Pure CDMA vs. Hybrid CDMA.
9. Compare: Multiple Access Techniques.
 - A. FDMA vs. TDMA vs. CDMA
 - B. Multiple Access in Cellular Systems.
10. Summary: Multiple Access Techniques.

Share Resources: Time & Frequency

..... and Code

1. In today's data communications systems, there is a need for several users to **share** a common channel resource at the **same time**, since the frequency spectrum is a finite and limited resource, and is regulated by governing agencies. Sharing the frequency spectrum is required to increase communication capacity.
2. The common channel resource could be:
 - A. Earth Station communication links to orbiting satellites.
 - B. High speed optical fiber links between continents.
 - C. Frequency spectrum in a cellular telephone system.
 - D. Twisted pair 'ethernet' cable in the work-place office.
3. Common methods for sharing available communication resources:
 - A. **Duplexing** communication signals,
 - B. **Multiplexing** communication signals, and
 - C. **Multiple Access** communication signals.
4. By using these methods, the shared resource (time and frequency spectrum) can be divided/shared among users, ensuring Quality of Service, increased capacity, and sufficiently low probability of interference between multiple Users.

Basic Single-Link Digital Communications System

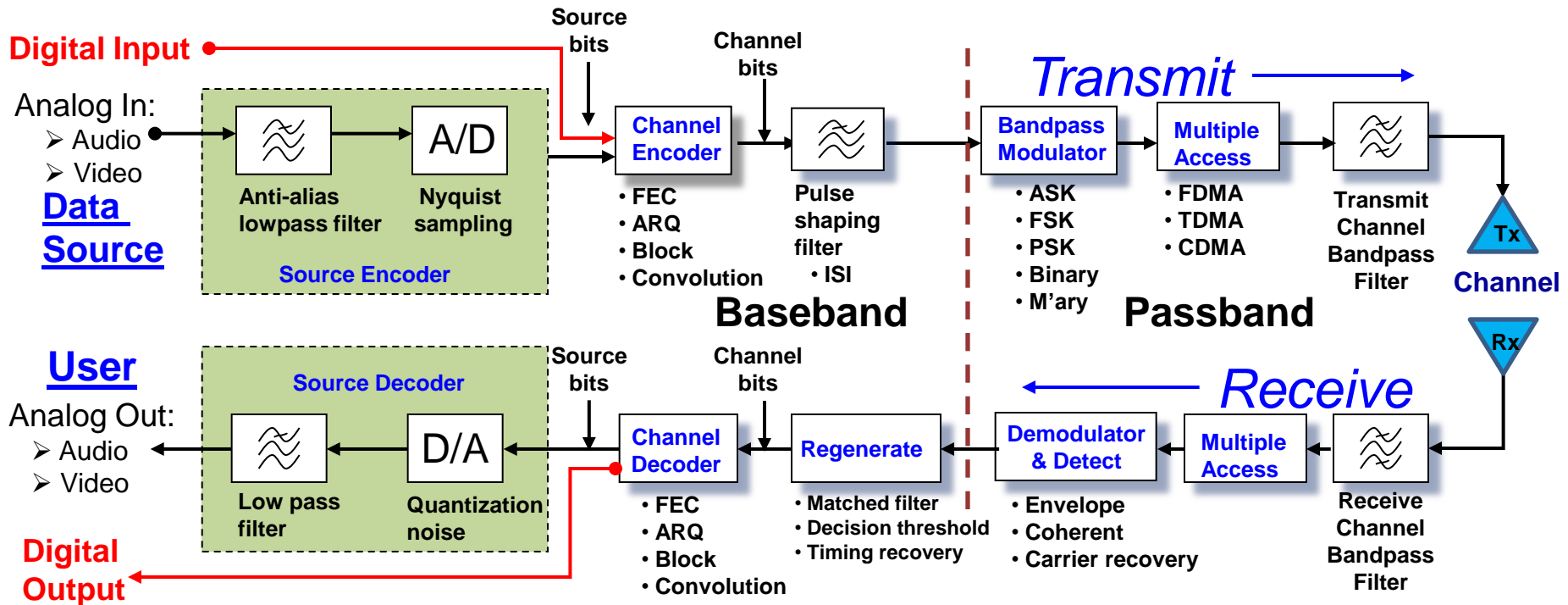

- Source** transmits signals (e.g. speech).
- Source encoder:** Samples, quantizes and compresses the analog signal.
- Channel encoder:** Adds redundancy to enable error detection or correction @ Rx.
- Modulator:** Maps discrete symbols onto analog waveform and moves it into the transmission frequency band.
- Physical channel** represents transmission medium: Multipath propagation, time varying fading, noise, etc.
- Demodulator:** Moves signal back into baseband and performs lowpass filtering, sampling, quantization.
- Channel decoder:** Estimation of information data sequence from code sequence → Error correction.
- Source decoder:** Reconstruction of analog signal.

Atlanta RF

Services, Software & Designs

Duplexing Methods

Overview

Duplexing is a method to separate the uplink & downlink transmissions:

1. Simplex Communication:

- A. Information is transmitted in one and only one pre-assigned direction. Only one user speaks (User A).
- B. Example: A satellite broadcasts television signals to your home (DirecTV). AM and FM broadcasting.

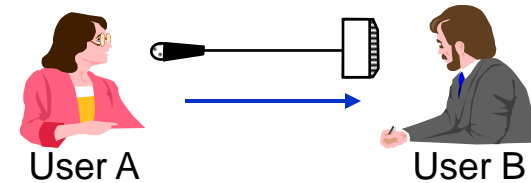

2. Half Duplex Communication:

- A. Information is transmitted in only one direction at a time. Users take turns speaking. Not simultaneous.
- B. Uses simplex communication operation at both ends.
- C. Example: Push-to-Talk 'walkie-talkie' style 2-way radios.

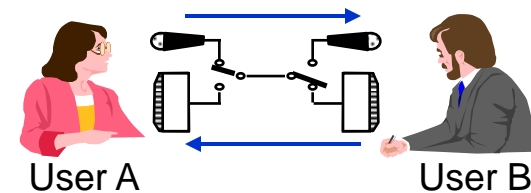

3. Full Duplex Communication:

- A. Information is transmitted & received in both directions simultaneously. Requires two independent links.
- B. In general, duplex operation require two frequencies in radio communication.
- C. May be achieved by simplex operation of two-or-more simplex at both ends.
- D. Example: Citizen's Band radios, land-based telephones and cellular telephones.

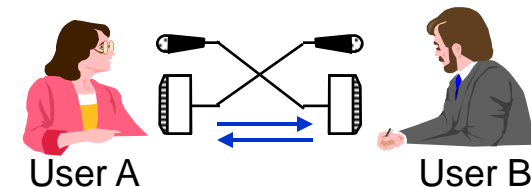

Duplexing can be implemented in the Frequency domain or in the Time domain, giving rise to either:

- A. FDD: Frequency Division Duplexing, or
- B. TDD: Time Division Duplexing.

Atlanta RF

Services, Software & Designs

Duplex Methods: FDD & TDD

Overview

Many wireless systems are full duplex. Duplexing techniques are needed to support simultaneous bidirectional communications on the same medium:

1. Frequency Division Duplex (FDD): In FDD, transmitters and receivers operate at different carrier frequencies: One for uplink signals and another for down link signals, which are separated to minimize interference between Tx and Rx signals.

- A. Used in all second generation cellular systems.
- B. Requires good frequency separation filters: Tx/Rx Diplexer filters.

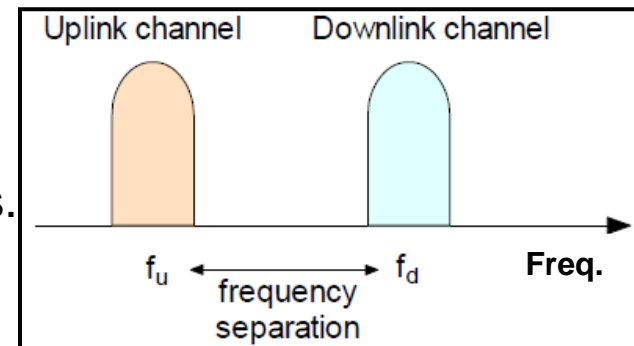

2. Time Division Duplex (TDD): TDD uses a single frequency band for both uplink and downlink signals. Then, it shares that band by assigning alternating time slots to uplink (forward time slot) and downlink (reverse time slot) signals.

- A. Eliminates the need for 2 separate frequency channels (Uplink frequency channel and Downlink frequency channel).
- A. Propagation delay/latency limits cell size.
- B. Very efficient for asymmetric traffic, e.g. internet download.
- C. Used in cordless systems (DECT) and wireless LANs.

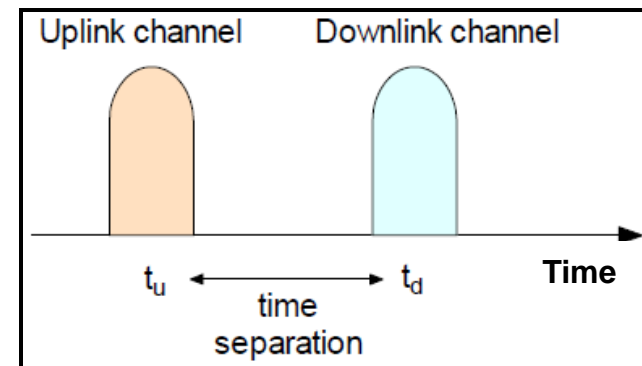

Atlanta RF

Services, Software & Designs

FDD: Frequency Division Duplex

Overview

1. Each User is assigned two frequency channels:

- A. One frequency for the uplink/reverse message signal: f_u .
- B. Another frequency for the downlink/forward message signal: f_d .

2. At the base station, separate transmit (Tx) & receive (Rx) antennas are used to accommodate the two separate frequency channels.

3. At the mobile unit, a single antenna (with duplexer bandpass filter) is used to enable Tx & Rx signals.

4. Users can Tx/Rx simultaneously.

5. Sufficient signal isolation between the Tx & Rx frequencies is necessary.

6. FDD is used exclusively in analog mobile radio systems.

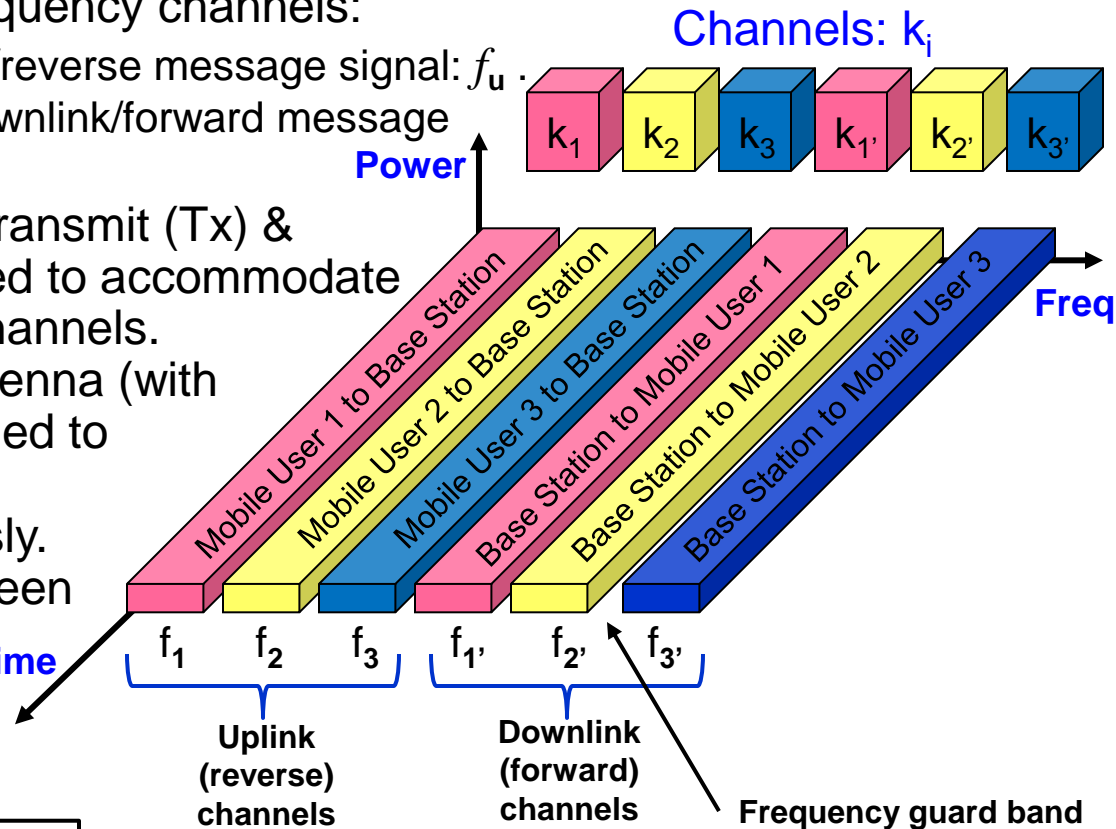

- **Uplink/reverse channel:** Direction of communication signals from a User's mobile terminal to a base station.
- **Downlink/forward channel:** Direction of communication signals from a base station to a User's mobile terminal.

Atlanta RF

Services, Software & Designs

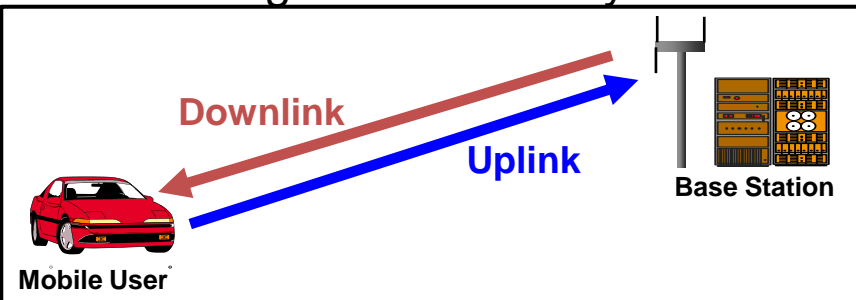

TDD: Time Division Duplex

Overview

1. TDD uses time to provide both a forward channel and a reverse channel, instead of using frequency (like FDD).
2. In TDD, multiple users share a signal radio frequency channel by taking turns in the time domain. A portion of the time is used to transmit (Tx) and a portion of the time is used to receive (Rx).
3. Individual users are allowed to access the channel in assigned **time slots**. Each duplex channel has both downlink time slots and uplink time slots.
4. If time separation between forward and reverse time slots is small, then transmission and reception of data appears simultaneous.
5. TDD allows communication on a single channel and does not need a duplexing bandpass filter, as does FDD.
6. TDD is only possible with digital transmission formats & modulation.

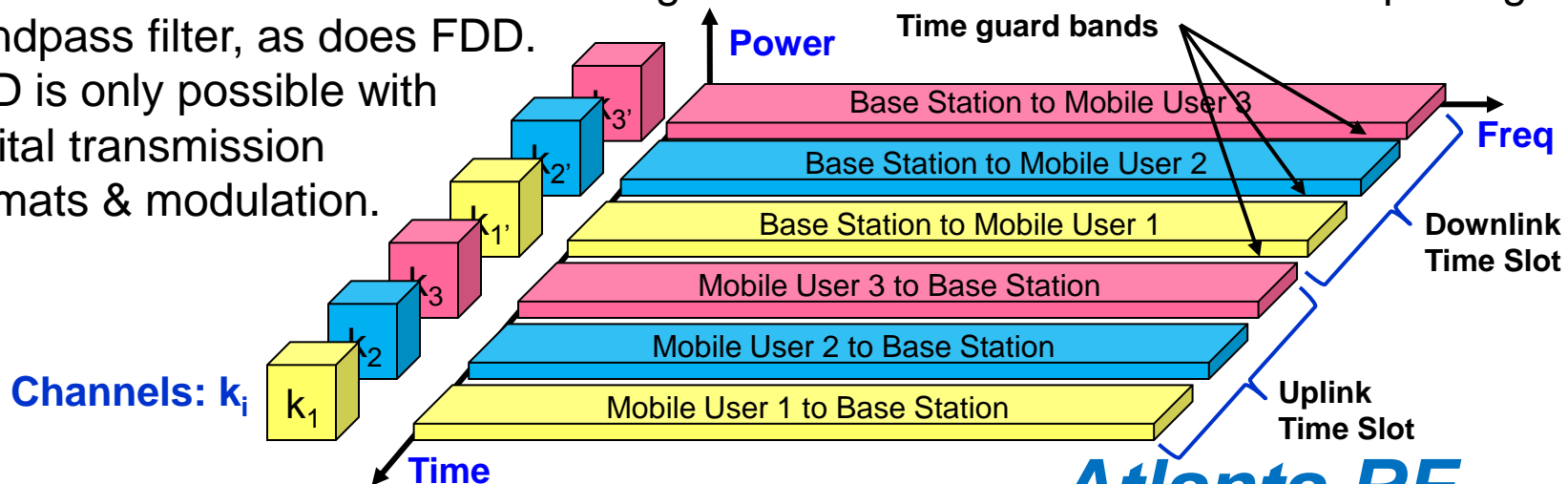

Atlanta RF

Services, Software & Designs

Compare: FDD & TDD

Attribute	FDD Characteristic	TDD Characteristic
Use of spectrum	High, including guard bands.	Less; No frequency guard bands.
Guard Time	No guard time is required.	Guard time is required between Tx and Rx.
Distance	Unlimited.	Shorter; depends on guard times.
Latency	Little or none.	Higher: Depends on range and Tx/Rx switching times.
Freq. Plan and Reuse	ACI is much lower than in a TDD scheme.	Frequency planning is required.
UL/DL Symmetry	Usually 50%/50% for UL/DL.	Asymmetrical time slots.
Dynamic Bandwidth Allocation	None.	Can be implemented.
MIMO and Beamforming	More difficult.	Easier.
Complexity	High	Low, but needs accurate timing.
Cost	Higher	Lower

ACI: Adjacent Channel Interference.

UL: Uplink channel.

DL: Downlink channel.

MIMO: Multiple Inputs/Multiple Outputs.

Multiplexing & Multiple Access

Overview

For multiple users to be able to share a common resource in a managed and effective way, it requires some form of *access protocol* :

A. Access protocol defines how or when the sharing is to take place and the means for identifying individual User messages. The sharing process is known as **multiplexing** in wired networks and **multiple access** in wireless digital communications.

B. Multiplexing is a method where multiple information-bearing analog message signals or digital data streams are combined into one more complex signal for transmission over a shared communication channel. Multiplexing at baseband frequencies: FDM, TDM & CDM.

C. Multiple Access is the ability for several terminals (= earth stations/mobile users) to connect to the same multi-point transmission medium (= satellite transponder/base station) to simultaneously transmit their respective carrier signals into it and share its data communication capacity (frequency spectrum), without severe degradation in the performance of the communication system. Multiple access at RF frequency: FDMA, TDMA & CDMA.

Multiplexing Principles

Sharing Communication Resources

1. When several communication channels are needed between the same two points, significant economies may be realized by sending all the messages on one transmission channel..... a process called ***multiplexing***.
2. Multiplexing is the process of partitioning the available communication resource into multiple channels along one of many directions: Time, frequency, code & space, and simultaneously transmitting over a single communication channel.
3. Multiplexing increases the number of communication channels so that more information can be transmitted and permits hundreds or even thousands of signals to be combined and transmitted over a single channel/medium.
4. Cost savings can be gained by using a single communication channel to send multiple information signals.
5. Four communication applications that would be prohibitively expensive or impossible without multiplexing are:
 - A. Telephone systems.
 - B. Tracking Telemetry & Control (TT&C).
 - C. Communication Satellites.
 - D. Radio & Television Broadcasting.

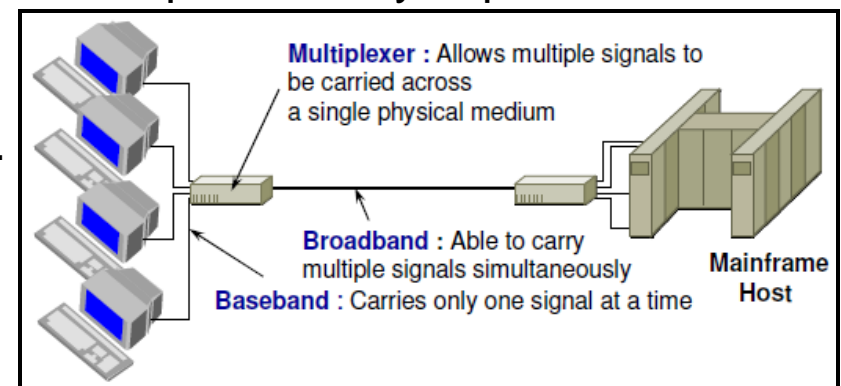

Multiplexing in 4 Dimensions

1. Multiplexing in 4 dimensions:

A. *Space* Multiplexing (s_i).

B. *Time* Multiplexing (t).

C. *Frequency* Multiplexing (f).

D. *Code* Multiplexing (c).

2. Goal: Multiple use of a shared medium.

3. Important: Guard spaces needed.

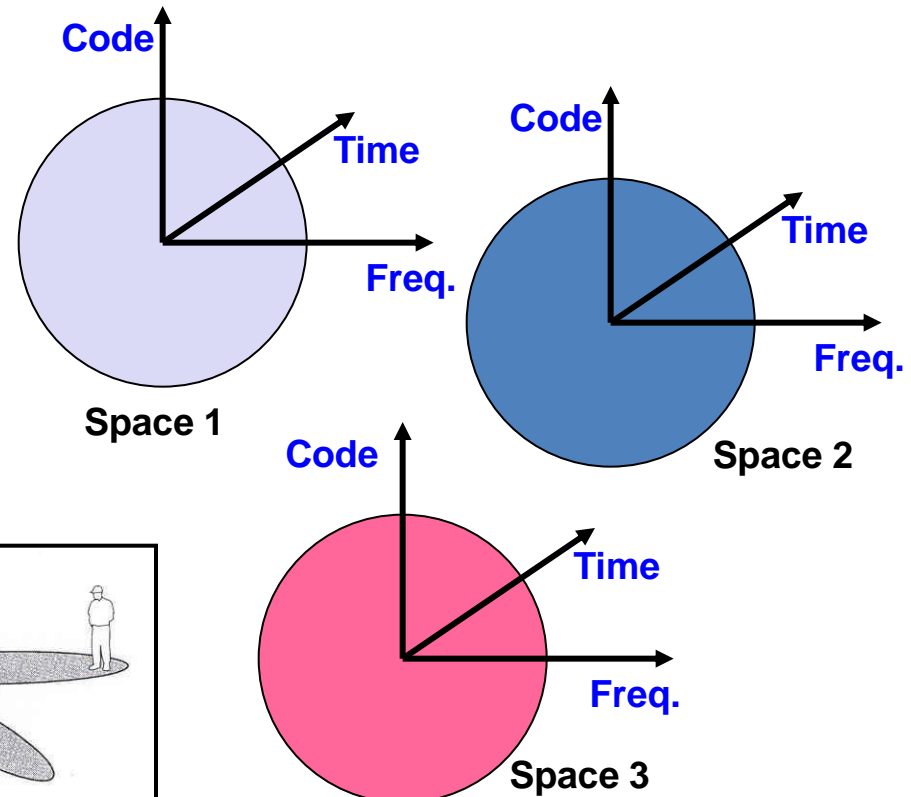
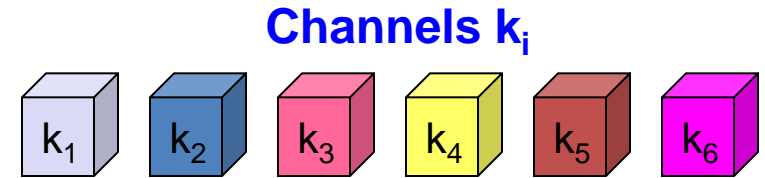
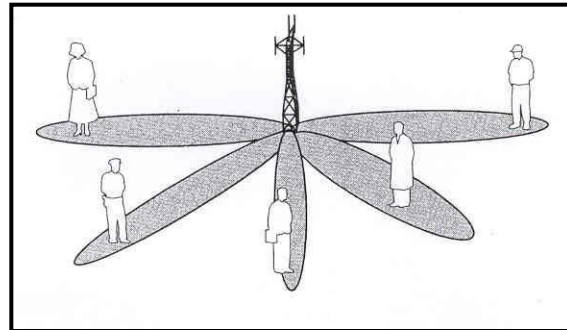

Space Division Multiplexing
Atlanta RF

FDM: Frequency Division Multiplexing

Overview

1. Frequency Division Multiplexing (FDM) divides the total frequency spectrum available to the communication system into smaller, *non-overlapping frequency bands* for transmission over a single digital communication channel. Each message is assigned a frequency slot within the available band.
2. A frequency band is allocated per channel for the entire transmission time. The signals are narrowband and frequency limited.
3. Frequency *guard bands* are placed between the User's frequency bands to avoid overlapping (ACI: *Adjacent Channel Interference*). Creates wasted bandwidth.
4. FDM can be used for digital or analog transmission.

5. Advantages of FDM:

- A. Lower channel bit rate means less susceptible to multi-path Inter-Symbol Interference (ISI).
- A. No dynamic coordination needed.
- B. FDM works for analog signals also.

6. Disadvantages of FDM:

- A. Inefficient use of bandwidth if is traffic distributed unevenly.
- B. Inflexible: Cannot readily support variable user data rates, fixed channel width means fixed bit rate.
- C. Requires guard bands between frequency channels.

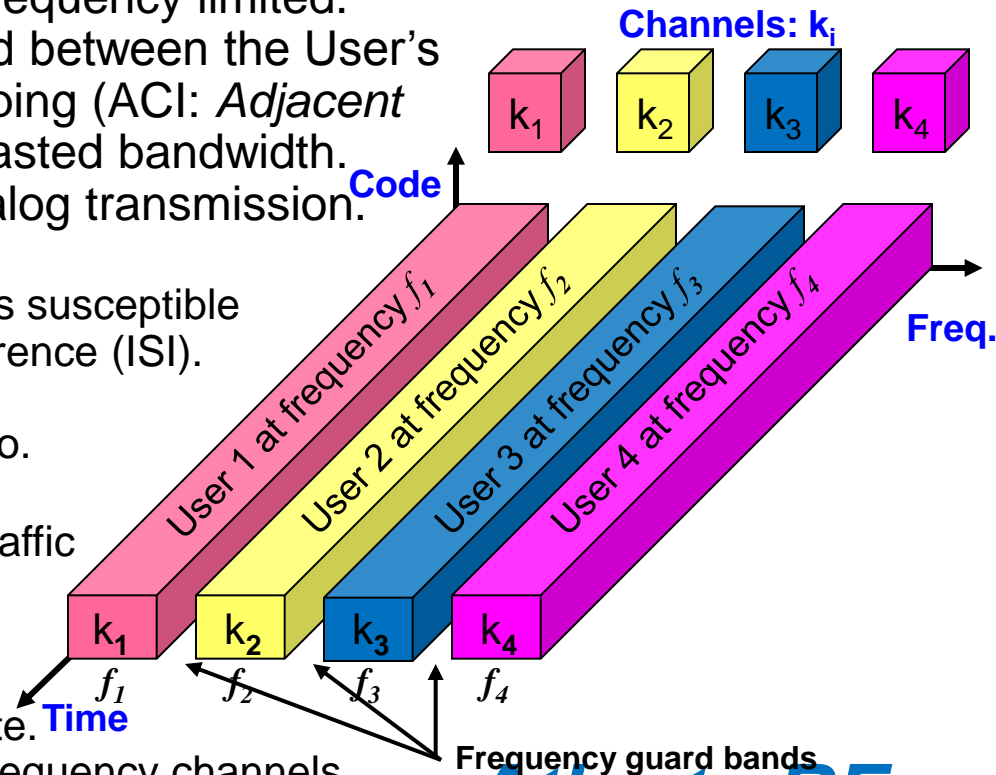

Frequency guard bands
Atlanta RF

Services, Software & Designs

TDM: Time Division Multiplexing

Overview

1. When a User transmits using TDM protocol, they occupy the whole frequency spectrum for a *certain amount of time*.
2. Guard times are used between each user's transmission *time burst* to minimize cross-talk and 'collisions' between channels.
3. TDM requires precise synchronization between senders, either by a precise clock or by a dedicated synchronization signal accessible to all senders.
4. Flexible: Users with heavy load can be assigned more sending time and Users with light load can be assigned less sending time.
5. Can be used with digital signals or analog signals carrying digital data.

6. Advantages:

- A. Only one carrier frequency in the medium at any given time.
- B. High throughput even for many users.
- C. Common Tx component design; only one power amplifier.

7. Disadvantages:

- A. Precise time synchronization necessary.
- B. Requires a Rx terminal to support a much higher data rate than the User's information rate. Must take into account propagation delays.

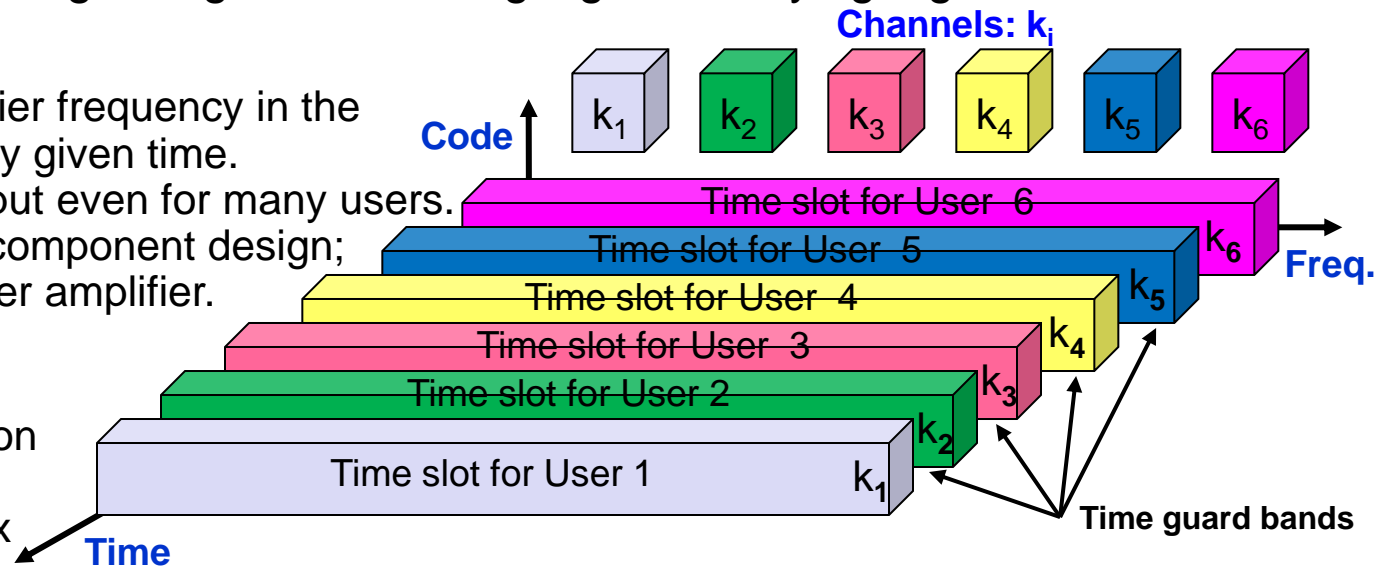

Atlanta RF

Services, Software & Designs

Time and Frequency Division Muxing

Overview

1. A channel can use a *certain frequency* band for a *certain amount of time*.
Deployed in GSM & DECT.
2. Guard spaces required in the time domain (to minimize cross-talk & 'collisions') and in the frequency domain (to minimize adjacent channel interference: ACI).
3. Robust against small-scale fading by using *frequency hopping* (= fast change of frequency bands).
4. Hybrid TDM/FDM *Advantages*:
 - A. Improved protection against tapping.
 - B. Improved protection against frequency selective interference.
 - C. Higher data rates compared to Code Division Multiplex.
5. Hybrid TDM/FDM *Disadvantages*:
 - A. Precise time coordination required: Sync & framing.

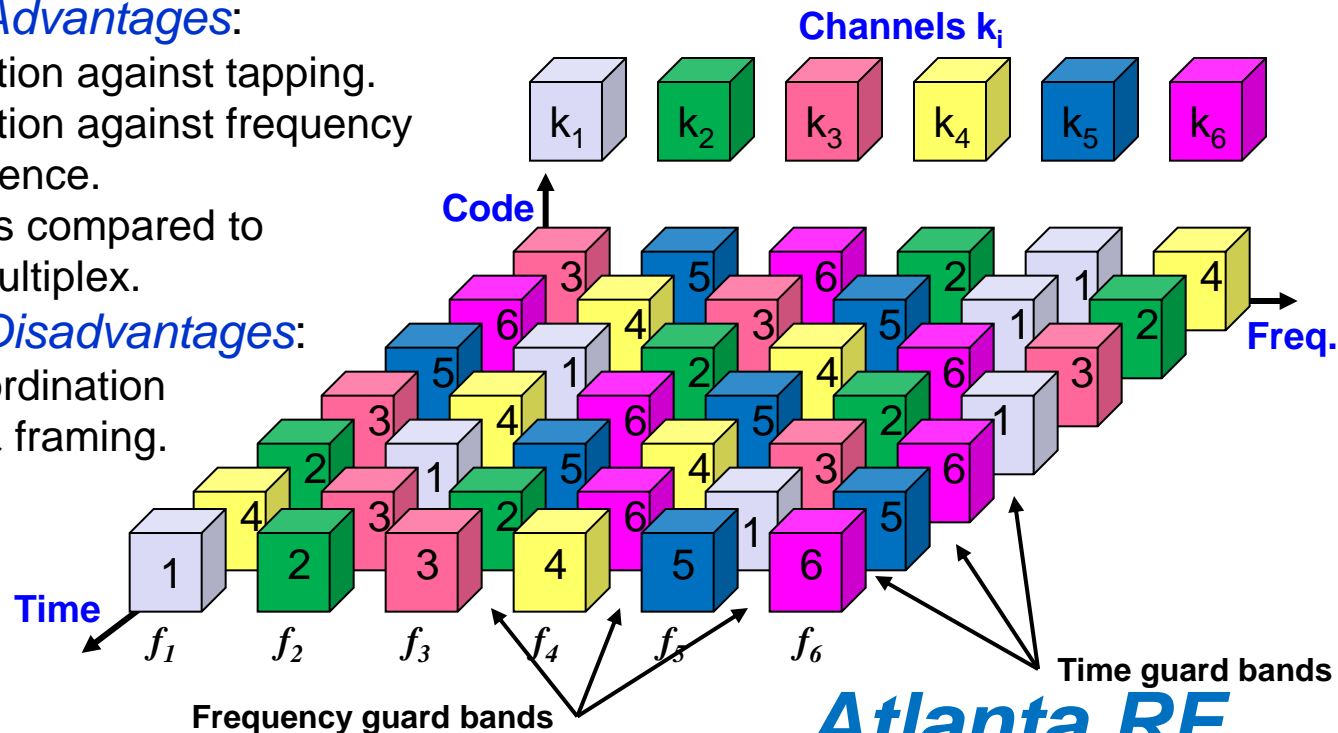

Atlanta RF

Services, Software & Designs

Code Division Multiplexing

Overview

1. CDM is a multiplexing method where multiple users are permitted to transmit simultaneously at the *same time* and at the *same frequency*.
2. Each user is assigned a *distinct code sequence*.
3. Separation by codes, guard spaces corresponds to the distance between codes (*orthogonal codes*).
4. Good protection against interference and tapping: i.e., *signals are spread* across a broad frequency band, and interpretation of a signal is only possible with a matching code.
5. Initially used in military application.
6. Multiplexing technique for UMTS/IMT-2000.
7. **Advantages:**
 - A. Bandwidth efficient & good power control.
 - B. No need for coordination and time synchronization.
 - C. Good protection against interference and tapping.
8. **Disadvantages:**
 - A. Lower user data rates due to high gains required to reduce interference.
 - B. Higher complexity at the receiver.
 - C. More complex signal regeneration.
9. Implemented using *spread spectrum technology*.

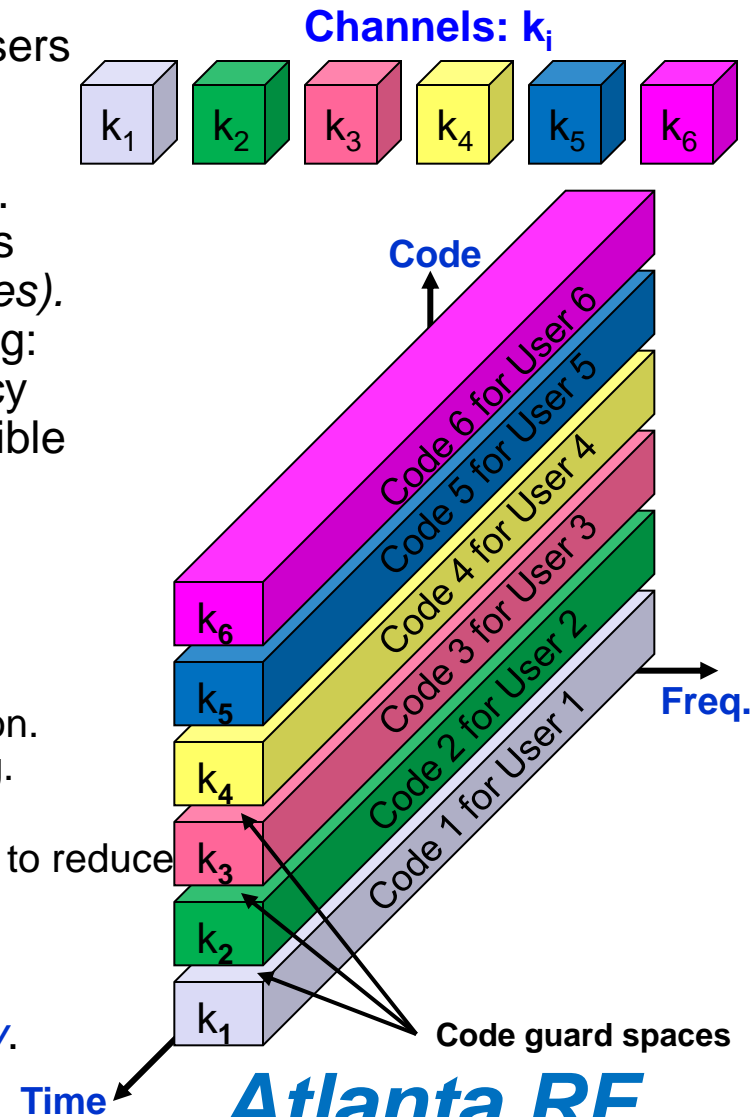

Multiple Access Techniques

Overview

1. Multiple access is a technique whereby the communication capacity of a common resource is shared among a large number of Users, and to accommodate the different mixes (like: voice, video, data, facsimile) of the communication traffic that are transmitted by different Users.
2. Multiple access is employed in most wireless systems, particularly in satellite systems and cellular systems.
3. The user's interface with the common resource (i.e., the satellite transponder) via an air interface at the physical layer.
4. Three primary Multiple Access techniques to **separate users** from each other, **inside** the common resource:
 - A. Use a unique frequency: **FDMA** (Frequency Division Multiple Access).
 - B. Use a unique time slot: **TDMA** (Time Division Multiple Access).
 - C. Use a unique code: **CDMA** (Code Division Multiple Access).
6. If the resource (frequency, time, code) is allocated in advance, it is called *pre-assigned* or fixed-assignment multiple access (**FAMA**). Common in voice-oriented networks.
7. If the resource is allocated in response to changing traffic conditions in a dynamic manner, it is called *demand assigned multiple access* (**DAMA**).

Atlanta RF

Services, Software & Designs

Types of Multiple Access Techniques

Channel Partitioning Protocols

1. **FDMA** (Frequency Division Multiple Access): Uses different frequencies for different users.
2. **TDMA** (Time Division Multiple Access): Uses same frequency but different time for different users.
3. **CDMA** (Code Division Multiple Access): Uses same frequencies and time, but different code sequences (3G wireless systems).
4. **SDMA** (Space Division Multiple Access): Uses spot beam antennas to separate radio signals by pointing at different users with different spot beams.
5. **DAMA** (Demand Access Multiple Access): Uses dynamic assignment protocol; allocates resources on request.
6. **RAMA**(Random Access Multiple Access):
 - A. Contention-based:
 - 1) Aloha.
 - 2) CSMA: Carrier Sense Multiple Access.
 - 3) Ethernet, 802.11.
 - B. Contention-free:
 - 1) Token-ring, FDDI.

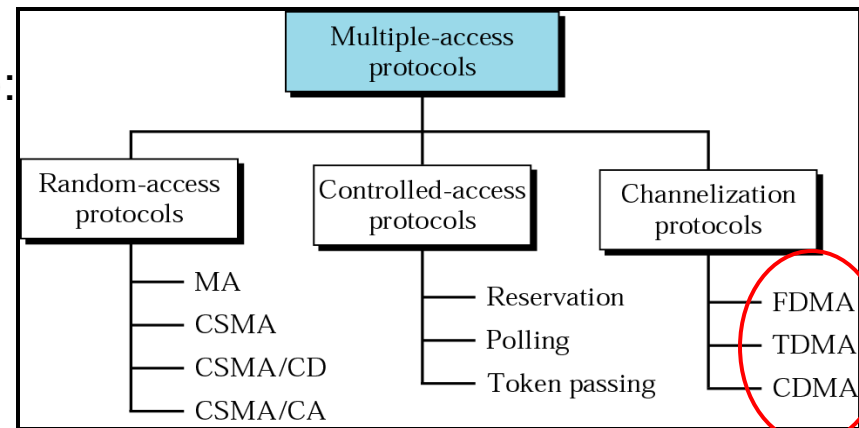

7. **Hybrid Multiple Accesses:** Time Division CDMA, Time Division Frequency Hopping, FDMA/CDMA, etc.

Multiple Access' Design Importance

1. The designer of a communication system must make decisions about the form of multiple access to be used.
2. The multiple access technique will influence:
 - A. The system's communication capacity.
 - B. The communication system's flexibility.
 - C. The communication system's costs.
 - D. The ability to earn revenue.
3. Basic problem in any multiple access system is how to permit a changing group of Users to share a common communication resource such that:
 - A. Communication capacity is maximized (*Revenue issue*).
 - B. Frequency bandwidth/spectrum is used efficiently (*Coordination issue*).
 - C. Interconnectivity (*Multiple coverage issue*).
 - D. Flexibility is maintained (*Demand fluctuation issue*).
 - E. Adaptability over its lifetime (*Traffic mix issue*).
 - F. User acceptance (*Market share issue*).
 - G. Cost to user is minimized.
 - H. Revenue to operator is maximized.

FDMA: Frequency Division Multiple Access

Overview

1. Frequency Division Multiple Access, or *FDMA*, is a channel access method used in multiple-access protocols as a channelization protocol. FDMA gives users an individual allocation of one or several frequency bands. It is particularly common-place in satellite communication. FDMA, like other Multiple Access systems, coordinates access between multiple users.
2. For FDMA, the available frequency spectrum of the communication system is divided into unique non-overlapping frequency bands or channels. These frequency channels are assigned to Users on-demand. Multiple Users cannot share a frequency channel. Users are assigned a channel as a pair of frequencies (Uplink/forward & Downlink/reverse channels), who all transmit simultaneously.

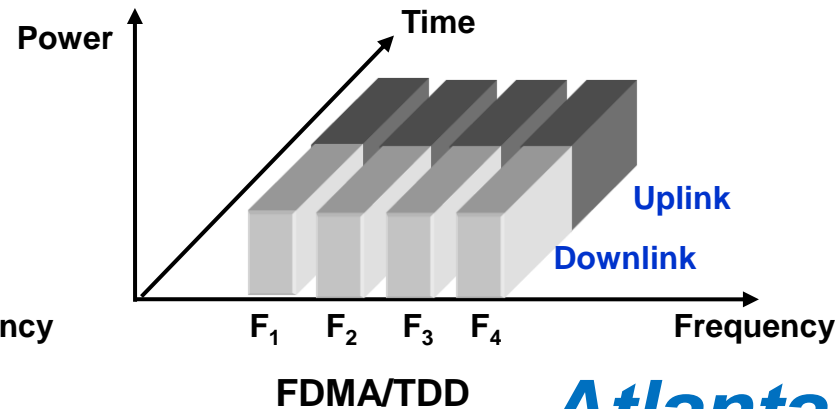
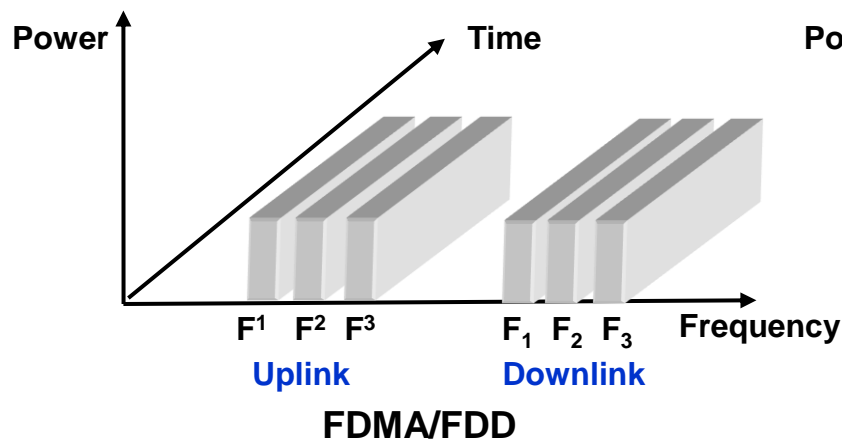

Atlanta RF

Services, Software & Designs

FDMA: Frequency Division Multiple Access

Principle of Operation

1. In FDMA, all users can transmit their signals simultaneously, which are separated from one another by their frequency of operation.
2. A single frequency is assigned to only one User at a time.
3. The Receiver's bandpass filter extracts the signal in the correct frequency slot. As such, the Receiver requires high quality narrow bandwidth bandpass filters to reject adjacent channel frequencies (other User's signals).
4. FDMA is hardware controlled; i.e.: Bandpass filters.
5. FDMA requires a frequency guard band between neighboring frequency channels to reduce adjacent channel interference (**ACI**) from other User signals. Guard bands are unused frequency slots, which results in a waste of available bandwidth.
6. Example: The available satellite channel bandwidth is broken into N frequency bands for different Earth Stations. These frequency bands are assigned to different users.

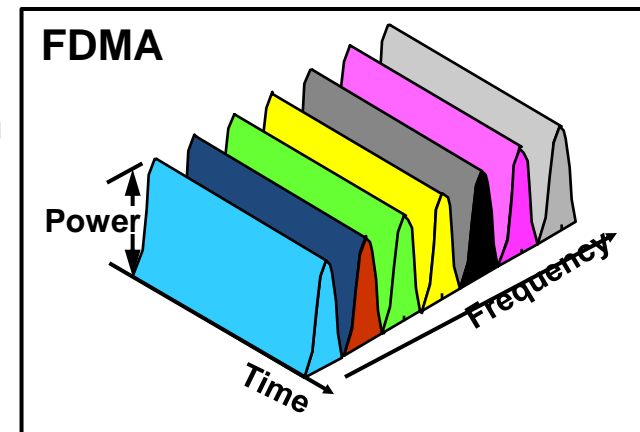
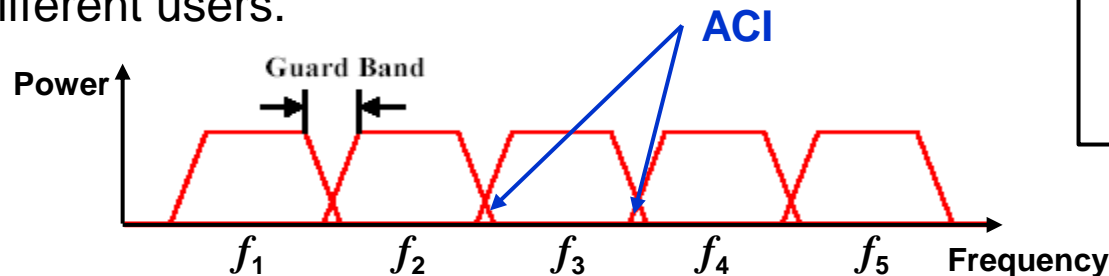

FDMA: Frequency Division Multiple Access

Features

1. FDMA channel bandwidths are relatively narrow (e.g., 30 kHz, 200 kHz), so several User signals may be present in, say, a satellite transponder's channel, whose bandwidth is large (36, 54 or 72 MHz). The satellite's high RF power amplifier is a non-linear device, which can produce inter-modulation products when multiple narrow-band User signals are amplified, which can interfere with other Users in the system.
2. Number of channels in a FDMA system:

$$N = \frac{B_{total} - 2B_{guard}}{B_c}$$

where: N = Number of channels.
 B_t = Total spectrum, Hz.
 B_{guard} = Guard band, Hz
 B_c = Channel bandwidth, Hz.

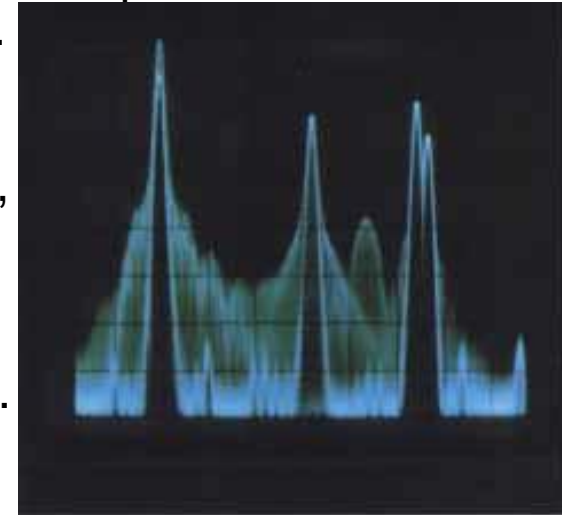

3. FDMA is not vulnerable to the timing problems (synchronization) that TDMA has. Since a predetermined frequency band is available for the entire period of communication, continuous stream data can easily be used with FDMA.
4. FDMA can be used for either digital or analog transmission
5. Applications: Broadcast radio & TV, analog cellular phone service.

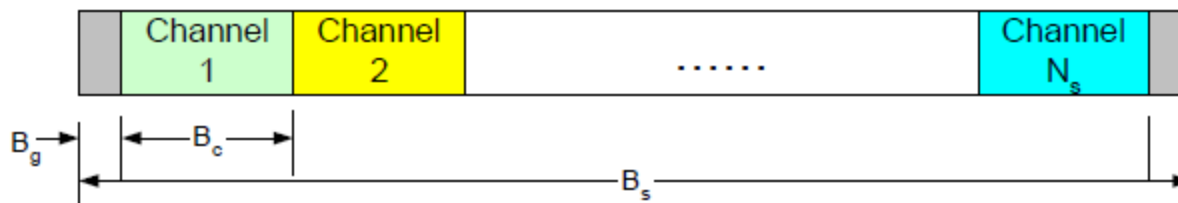

MHz *ita* RF

FDMA in First Generation (1G) Analog Radio

Uses analog modulation:

- A. FM modulation, or
- B. PM modulation.

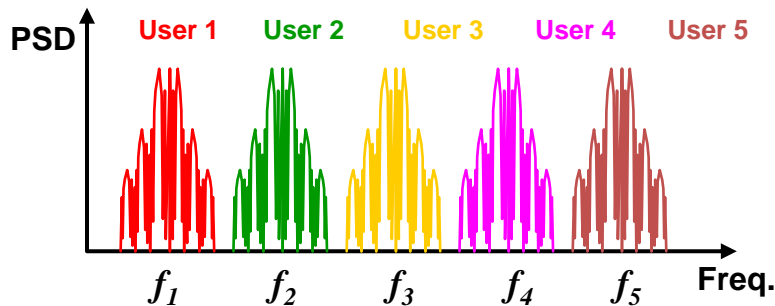

The amplitude of the RF signal is constant.

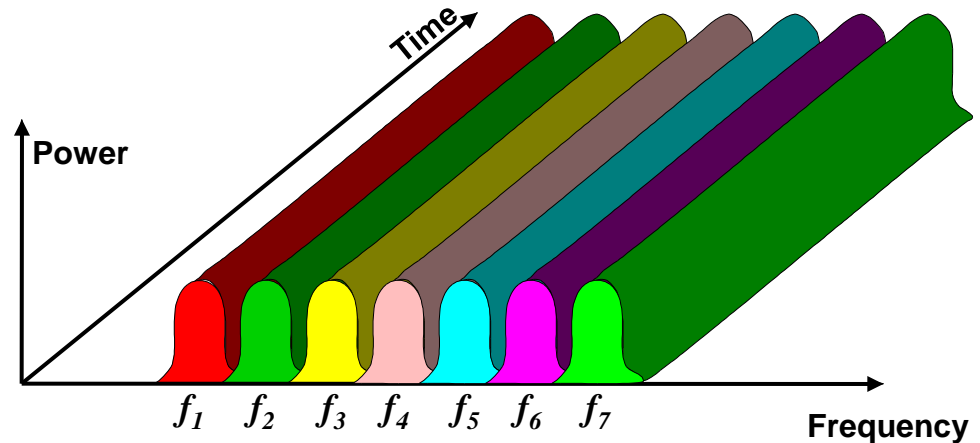

Each channel has its own dedicated carrier frequency and frequency bandwidth.

<u>Phone System (Retired)</u>		<u>Countries</u>
AMPS	Advanced Mobile Phone System	U.S./Canada
TACS	Total Access Communication System	U.K. + 21 countries
NMTS	Nordic Mobile Telephone System	Nordic countries
C-450		Germany
NTT	Nippon Telegraph & Telephone	Japan

Atlanta RF

Services, Software & Designs

Simplified block diagram of a traditional FDM/FM/FDMA earth station

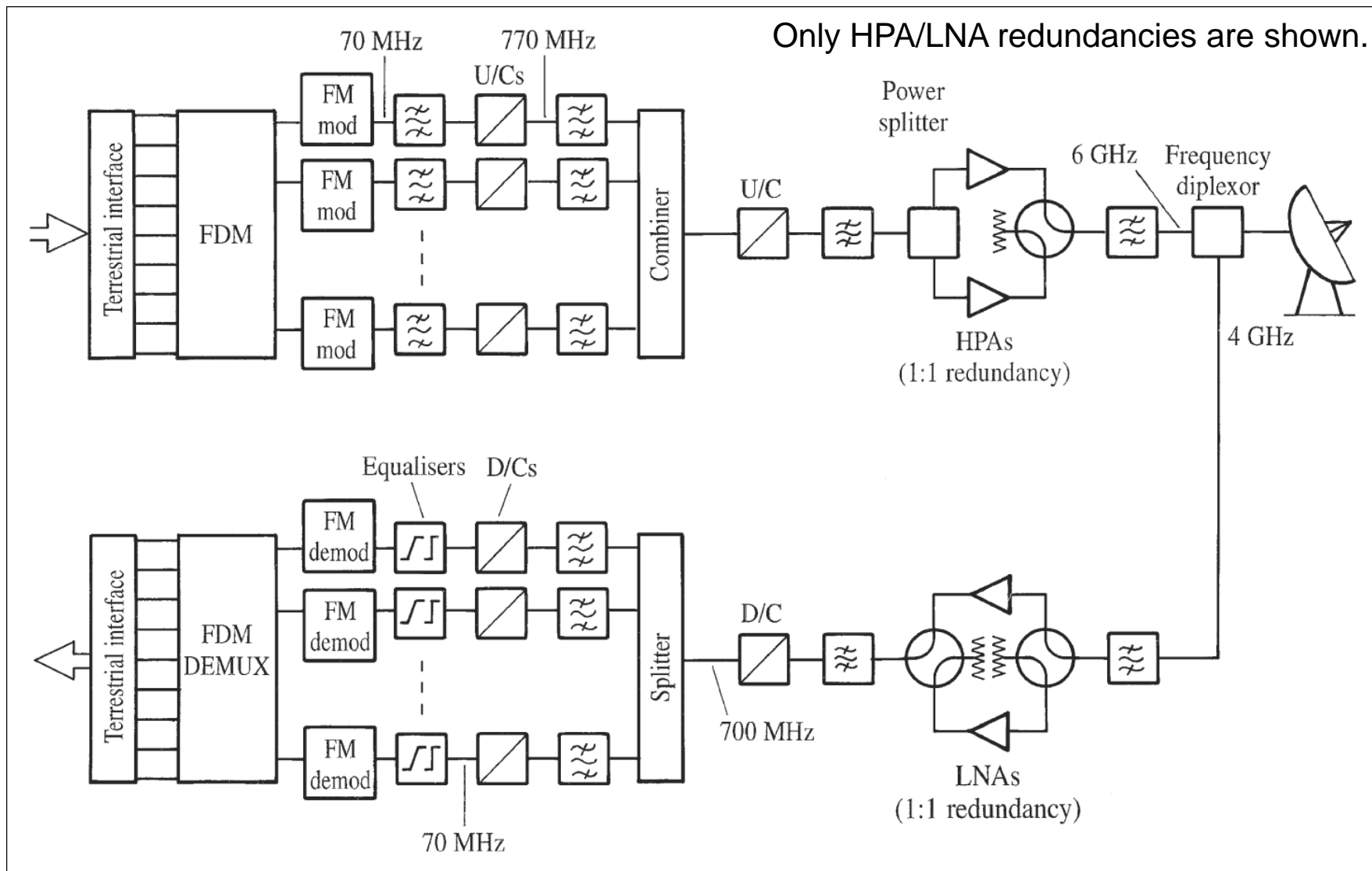

FDMA: Advantages & Disadvantages

1. FDMA *Advantages*:

- A. Uses well-established technology. Simplest and cost-effective to implement.
- B. No need for network timing. Generally less supervisory control required.
- C. Can achieve lowest bandwidth and power requirements.
- D. No restriction regarding the type of baseband or the type of modulation.
- E. Quickest customer acceptance. Cheapest.

2. FDMA *Disadvantages* & Limitations:

- A. The need for frequency guard bands. . . . waste of resources.
- B. Intermodulation (IM) products cause Carrier-to-Noise ratio (C/N) to fall.
 - 1) Back-Off of power amplifier is needed to reduce IM.
 - 2) Parts of frequency band cannot be used because of IM.
- C. Power balancing must be done carefully.
- D. Inter-modulation noise in the transponder leads to interference with other links → satellite capacity reduction.
- E. Lack of flexibility in channel allocation; hardware controlled.
- F. Requires up-link power control to maintain quality.
- G. Weak carrier tends to be suppressed.

TDMA: Time Division Multiple Access

Overview

1. In TDMA, a single carrier frequency with a wide frequency bandwidth is shared among multiple users. Each user is assigned a non-overlapping time slot to transmit and to receive RF signals.
2. Transmission for TDMA users is not continuous, but occurs in bursts. TDMA systems buffer the User's data, until its turn (its time slot) to transmit comes. This is called **buffer-and-burst** method.
3. Transmission from users are interlaced into a cyclic time structure.
4. To synchronize the timing between Users, a reference station defines the frame clock by transmitting its **reference burst**. All the network traffic stations must synchronize themselves to the reference station by locating their burst with a constant delay with respect to the reference burst station.
5. TDMA is more flexible, as a number of time slots may be combined to give a higher capacity to a user. Furthermore, number of slots combined can be varied for serving different user requirements: **Bandwidth on demand**.
6. TDMA is used for digital communication and cannot be used in analog communication. Modulation must be digital to accommodate the intermittent nature of transmission (= time bursts).

TDMA: Time Division Multiple Access

Principle of Operation

1. In TDMA, different users are assigned different time slots, but use the same frequency carrier. In each fixed time slot, only one user is allowed to either transmit or receive. Unused time slots are idle. . . . Waste of resource.
2. Periodic time slots are allocated to message signals in a non-overlapping manner (in the time domain) so individual messages can be recovered from time-synchronized switches.
3. The communication channel is divided into **frames** of length T_f . Each frame is further segmented into N **subinterval** called **slots**, each with duration $T_s = T_f/N$, where N is the number of users.
4. Each user is assigned a slot (or channel) within each time frame. The number of time slots per frame is a design parameter depending on requirements such as: Modulation, bandwidth, data rate, etc.
5. Time guard slots are necessary to separate users.
6. Applications for TDMA:
 - A. Telephone backbone,
 - B. GSM digital cellular phones,
 - C. Digital cordless phones.

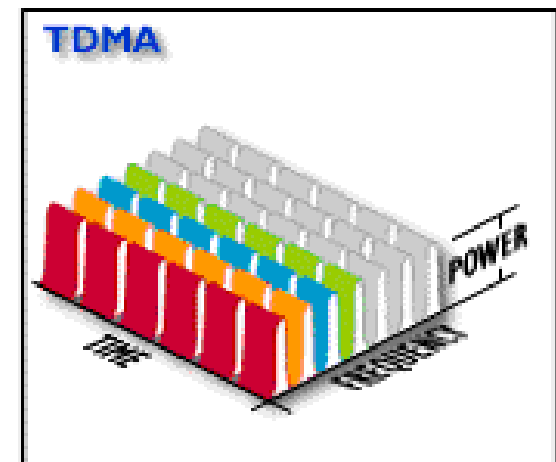

TDMA in Satellite Communication

1. TDMA is a method of time division multiplexing digitally modulated carriers between participating earth stations with a satellite network through a common satellite transponder. Only one carrier is allowed access to the transponder at any given time. The transponder is *time shared* between the different users.
2. With TDMA, each station transmits a short burst of a digitally modulated carrier during precise non-overlapping time slot within a TDMA frame. Each earth station's burst is *synchronized* so that it arrives at the satellite at different times.
3. Thus, only one earth station's carrier signal is present in the satellite's transponder at any given time, thereby avoiding a '*collision*' with another earth station's carrier signal.
4. The transponder receives the earth station's transmissions and retransmits them in a down-link beam that is received by all the participating earth stations.
5. The transmitted bursts must contain timing synchronization and identification information that help receiving earth stations *extract* the required information without error.
6. Each earth station receives the bursts from all other earth stations and *must select* from them the traffic destined only for itself.

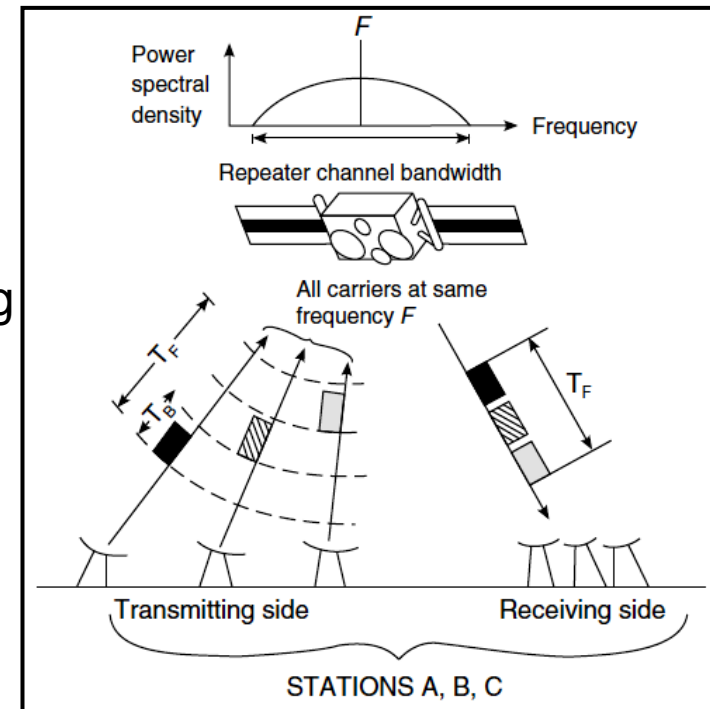

FAMA-TDMA in Satellite Communication

Fixed-Assignment Multiple Access Time Division Multiple Access

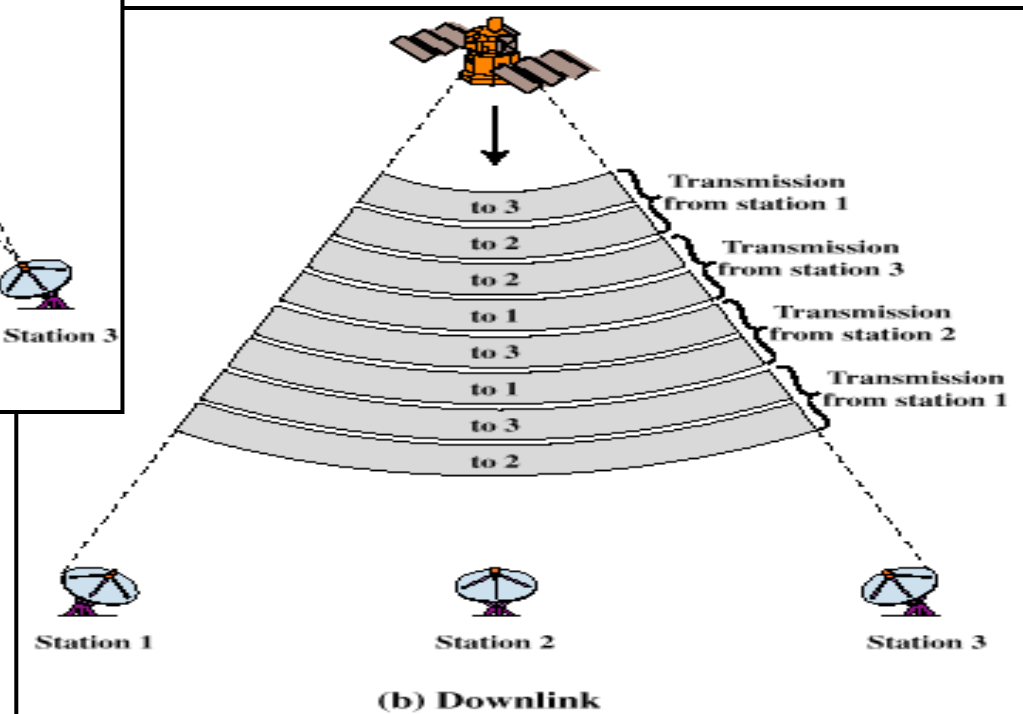
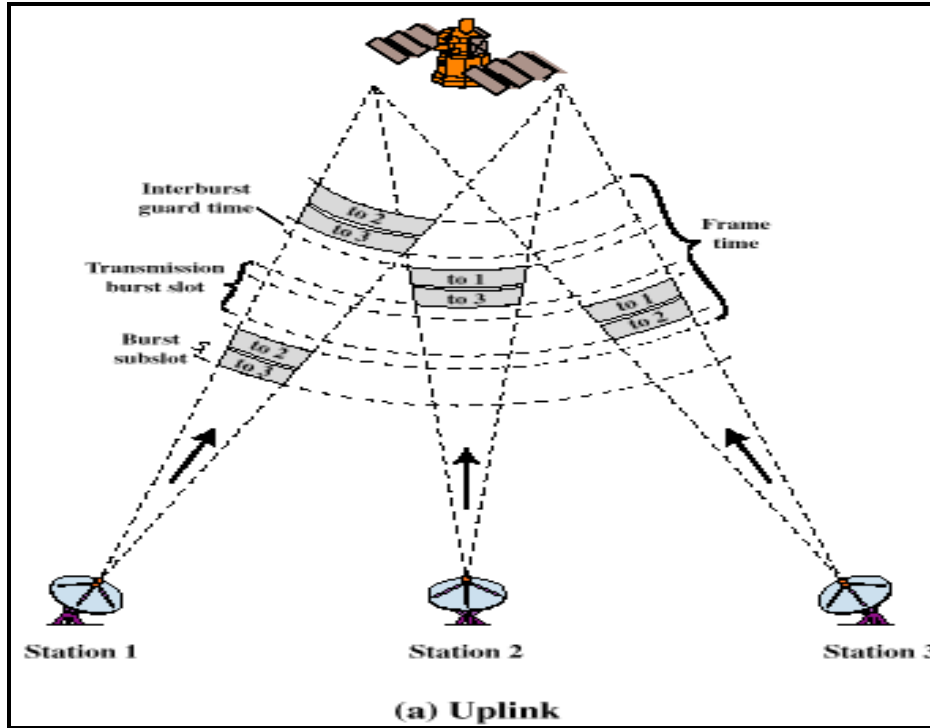

Atlanta RF

Services, Software & Designs

TDMA: Second Generation (2G) Digital Radio

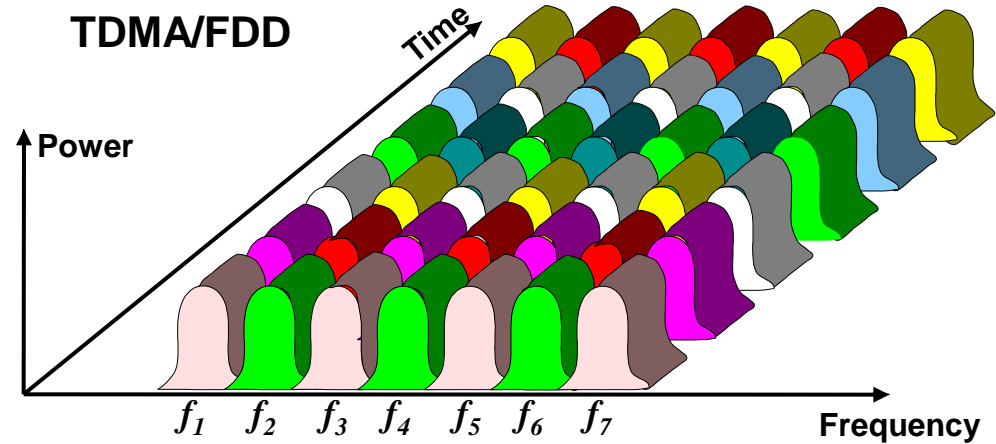
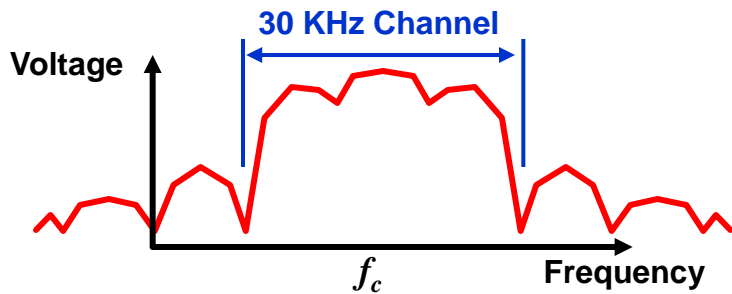

Each channel has its own dedicated carrier frequency and frequency bandwidth.

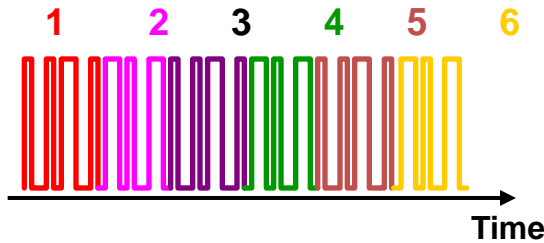

Quadrature Phase Shift Keying (QPSK) Modulation	10	00
	★	★
	11	01
	★	★

<u>Main Systems:</u>		<u>Countries</u>
DAMPS	Digital Advanced Mobile Phone System (Formerly NADC, North American Digital Cellular)	U.S./Canada
GSM	Global System for Mobile Communications	Europe/World

TDMA Repeating Frame Structure

1. TDMA requires centralized control, whose primary function is to transmit a periodic **reference burst** that defines a time **frame** and forces a measure of synchronization of all the users.
2. The frame is divided into time slots, and each user is assigned a Time Slot in which to transmit its information and who uses the entire channel bandwidth.
3. Time frame structure:
 - A. Header:** Guard (ramp) time for receiver synchronization between time slots.
 - B. Sync. Bits:** Used to establish bit synchronization (also for equalizer training).
 - C. Control Bits:** Used for handshaking, control, and supervisory messages.
 - D. Information Bits:** Coded or uncoded information bits, may include pilot symbols/sequences for channel measurement and equalizer training.
 - E. Guard Bits:** Prevents overlap at base of time slots arriving from different Users.

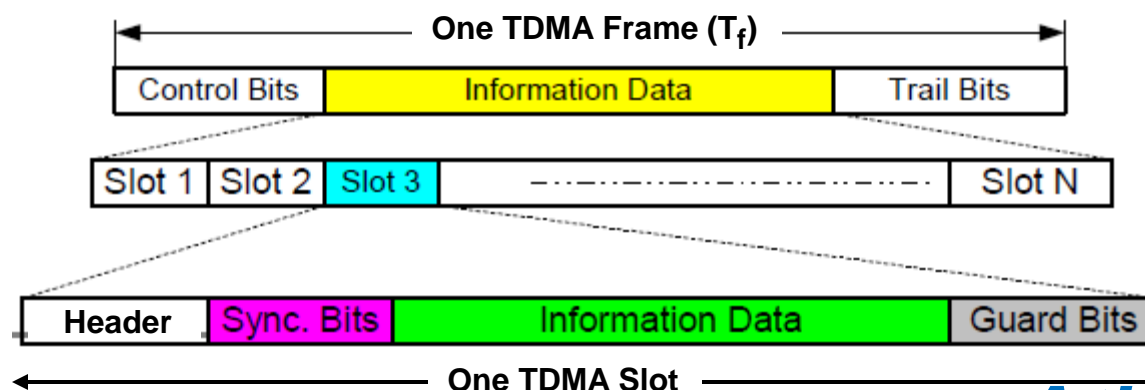

TDMA: Number of Channels

1. The number of channels: N , in a TDMA system is:

$$N = \frac{m(B_{total} - 2B_{guard})}{B_c}$$

where: N : Number of channels.

m : Number of users per radio channel.

B_{total} : Total spectrum allocation, Hz.

B_{guard} : Guard Band, Hz.

B_c : Channel bandwidth, Hz.

2. Example: Number of channels in Global System for Mobile (GSM)

A. GSM uses TDMA/FDD protocol.

B. Forward link spectrum at $B_{total} = 25$ MHz.

C. Radio channel bandwidth of $B_c = 200$ kHz.

D. If $m = 8$ speech channels are supported, and

E. If no guard band ($B_{guard} = 0$ Hz) is assumed :

$$N = \frac{8(25\text{MHz})}{200\text{kHz}} = 1000 \text{ simultaneous Users}$$

Hybrid TDMA: TDMA/TDD and TDMA/FDD

1. In TDMA/TDD system, half of the time slots in the frame's information message are used for the forward link channels and half the time slots are used for reverse link channels. Same channel conditions.
2. In TDMA/FDD systems, the same frame structure can be used for both forward & reverse transmission, but a different carrier frequency is used for a reverse link channel or for a forward link channel:
 - A. Different frames travel in each carrier frequency in different directions.
 - B. Each frame contains the time slots either for reverse channels.

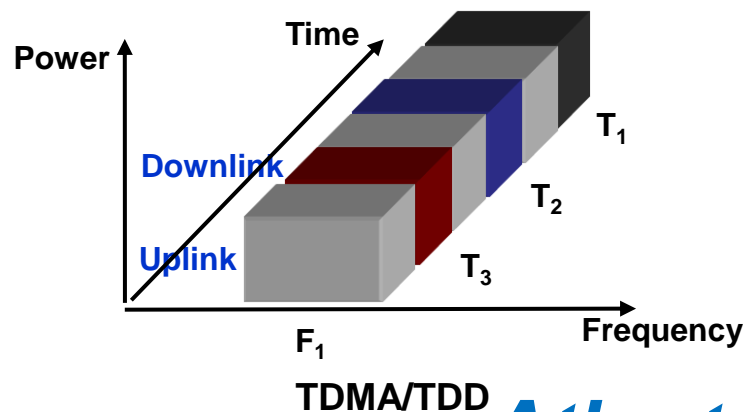
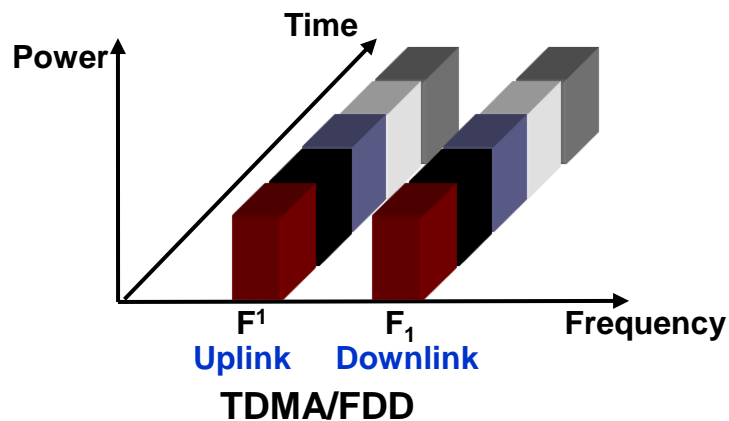

TDMA: Advantages & Disadvantages

1. TDMA *Advantages*:

- A. Bandwidth efficient protocol: No frequency guard band between channels.
- B. No need for precise narrow bandwidth filters, as is needed in FDMA.
- C. Easy to reconfigure for changing traffic demands.
- D. More robust against noise and interference. TDMA's technology separates users in time, ensuring that they will not experience interference from other simultaneous transmissions.
- E. Easy transmission plans: Capacity management is simple and flexible. A flexible Burst Time Plan optimizes capacity per connection.
- F. No intermodulation products, since TDMA uses one carrier frequency at a time.
- G. Power amplifier can operate in saturation for maximum transmit RF power: No back-off needed. Uplink power control is not required.
- H. Good for digital communications and for satellite on-board processing.

2. TDMA *Disadvantages*:

- A. Complex: The need for data storage requires the use of A/D conversion, digital modulation, time slot and time frame synchronization.
- B. Requires network-wide timing synchronization.
- C. Subject to multipath distortion because of its sensitivity to timing.
- D. Each user must transmit at a common burst rate that is much higher than user's required rate: High burst rate.
- E. Requires complicated channel equalization in mobile systems.

Simplified block diagram of traditional TDM/QPSK/TDMA Earth Station

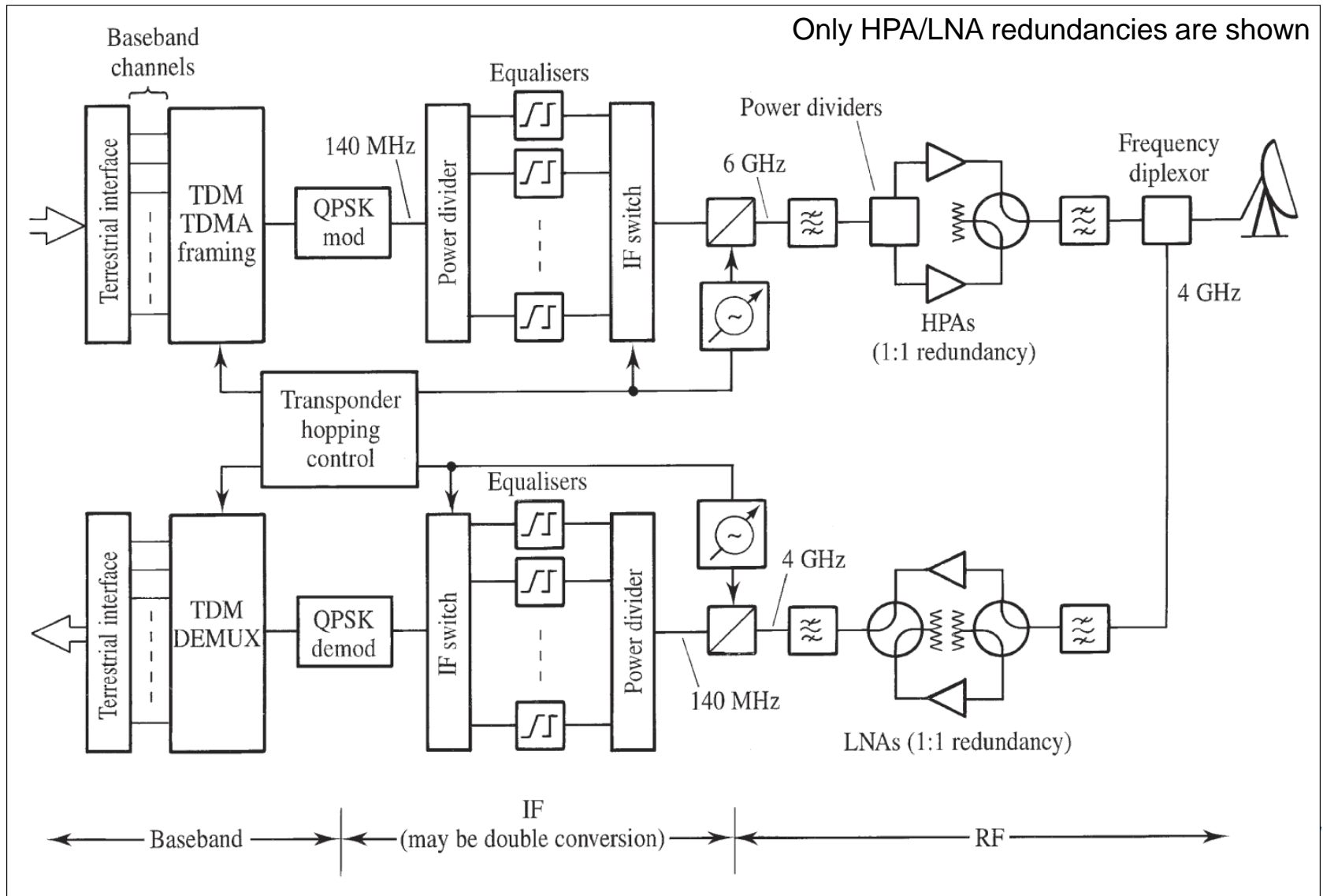

CDMA: Code Division Multiple Access

Overview

1. In CDMA protocol, all users can transmit simultaneously at the *same time* and on the *same carrier frequency*, and are distinguished by digital codes.
2. Each User signal is assigned a *unique digital code sequence* to separate it from multiple users, so that **User A** does not respond to a code intended for **User B**. The unique code sequence is used to encode the User's digital data signal before modulation. The receiver, knowing the code sequence of the User, decodes the received signal and recovers the original data. All other sender signals seem like *noise* with respect to the desired signal.
3. The bandwidth of the coded data signal is chosen to be much larger than the bandwidth of the User's original data signal; that is, the encoding process enlarges (*spreads*) the spectrum of the User's original data signal.
4. The spreading signal is a pseudo-noise (PN) code sequence that has a code rate (or *chip rate*) which is orders of magnitudes greater than the data rate of the User's message. The assigned PN code is unique to every User.
5. CDMA is also called **Direct Sequence Spread Spectrum**, or just: DSSS.

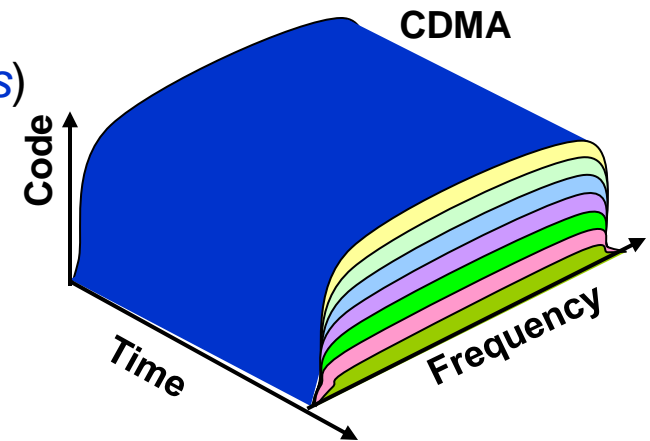

Atlanta RF

Services, Software & Designs

CDMA is a Spread Spectrum System

Code Set Partitioning

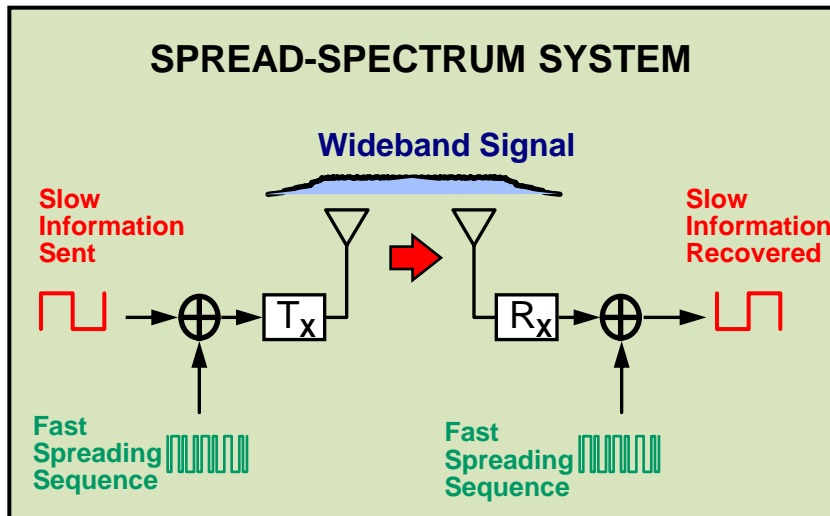
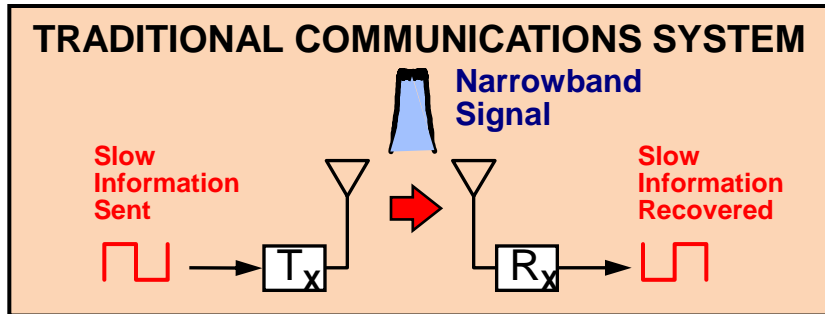

Spread Spectrum Payoff: *Processing Gain*

1. Traditional technologies try to squeeze the signal into the minimum required bandwidth.
2. Direct Sequence Spread Spectrum systems mix their input data with a fast spreading sequence and transmit a wide frequency bandwidth signal.
3. The spreading sequence is independently regenerated at the receiver and mixed with the incoming wideband signal to recover the original data.
4. The de-spreading gives substantial *gain*, proportional to the bandwidth of the spreading signal.
5. CDMA uses a larger bandwidth than the original signal, but then uses the resulting processing gain: G_p to increase system's capacity.

Atlanta RF

Services, Software & Designs

CDMA: Transmit & Receive

1. CDMA signal **transmission** consists of the following steps:
 - A. A high data rate pseudo-random code sequence is generated, different for each frequency channel/user and for each successive connection.
 - B. The narrowband information data modulates the pseudo-random code, thereby dividing the signal into smaller bits and thus increasing its bandwidth: The information data is “spread” (spread spectrum).
 - C. The resulting signal modulates an RF carrier frequency signal.
 - D. The modulated RF carrier signal is amplified and broadcast.

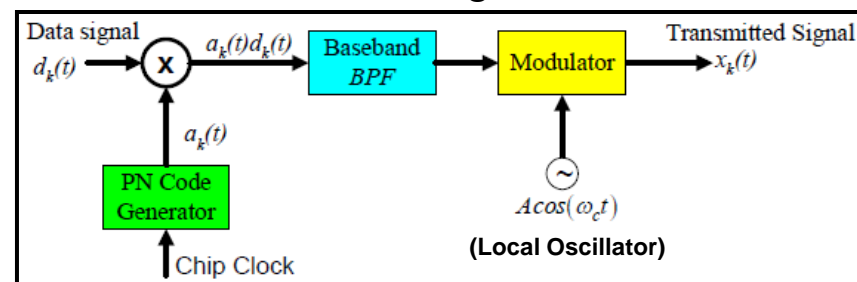

2. CDMA signal **reception** consists of the following steps:
 - A. The RF carrier frequency signal is received and amplified.
 - B. The RF received signal is mixed with a local oscillator carrier frequency signal to recover the spread digital signal.
 - C. A pseudo-random code is generated, matching the anticipated signal.
 - D. The receiver acquires the received code and phase locks its own code to it.
 - E. The received signal is correlated with the generated code, extracting the user's original information data.
3. If multiple users transmit a spread-spectrum signal at the same time, the receiver will still be able to distinguish between users, provided that each user has a unique spreading code that has a sufficiently low cross-correlation with the other spreading codes.

DS-CDMA: Direct Sequence CDMA

Overview

DS-CDMA: Direct Sequence CDMA

- A. The original information-bearing data signal is multiplied directly by the high chip rate pseudorandom spreading code whose bandwidth is much greater than the signal itself: Spreading its bandwidth.
- B. The speed of the code sequence is called the *chipping rate* (chips per second).
- C. The pseudorandom sequence directly phase modulates an RF carrier signal, which increases the bandwidth of transmission and lowers the power spectral density.
- C. The resulting RF signal has a noise-like spectrum. Noise to others, but not to the intended receiver.
- D. The amount of spreading is dependent upon the ratio of chips per bit of information, which is the processing gain: G_p for DSSS.
- E. Applications:
 - 1) GPS: Global Positioning Satellite.
 - 2) IS-95 and IS-136 Cellular CDMA
 - 3) UMTS and Wideband CDMA (WCDMA).

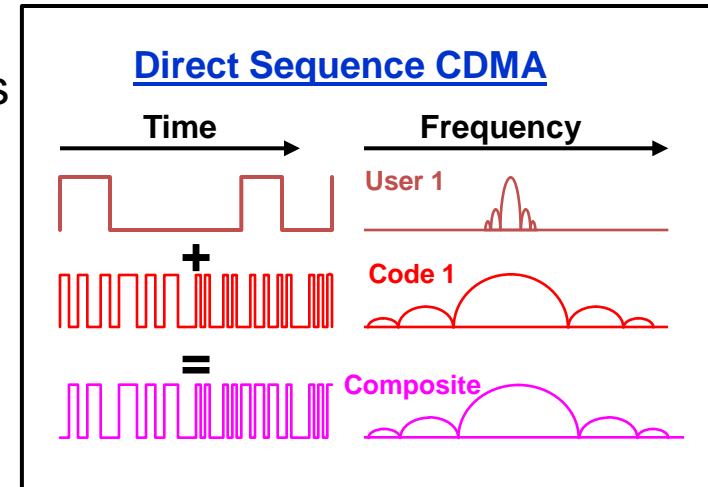

FH-CDMA: Frequency Hopping CDMA

Overview

FH-CDMA: Frequency Hopping CDMA

- A. The carrier frequency: f_c is rapidly changed from one frequency channel to another during radio transmission: The order of frequencies selected by the transmitter is decided by the spreading code, at a specific hopping rate: R_h . Dwell time period at each frequency is: $T_h = 1/R_h$.
- B. The RF signal is dehopped at the receiver end using a frequency synthesizer controlled by a pseudo-random code sequence generator.
- C. Can avoid narrowband interference.
- D. No near-far problem (Operate without power control).
- E. Low Probability of Detect/Intercept (LPD/LPI).
- F. Applications:
 - 1) Military for LPD/LPI feature.
 - 2) Part of original 802.11 standard.
 - 3) Enhancement to GSM.
 - 4) Bluetooth.

TH-CDMA: Time Hopping CDMA

- A. The original information-bearing data signal is not transmitted continuously. Instead, the signal is transmitted in short bursts, where the times of the bursts are decided by the spreading code. The receiver knows beforehand when to expect the time burst.

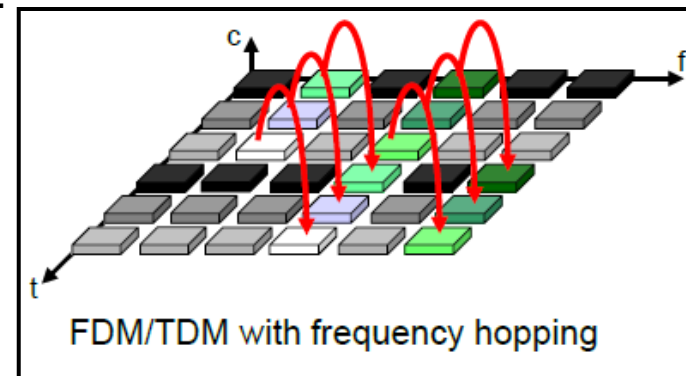
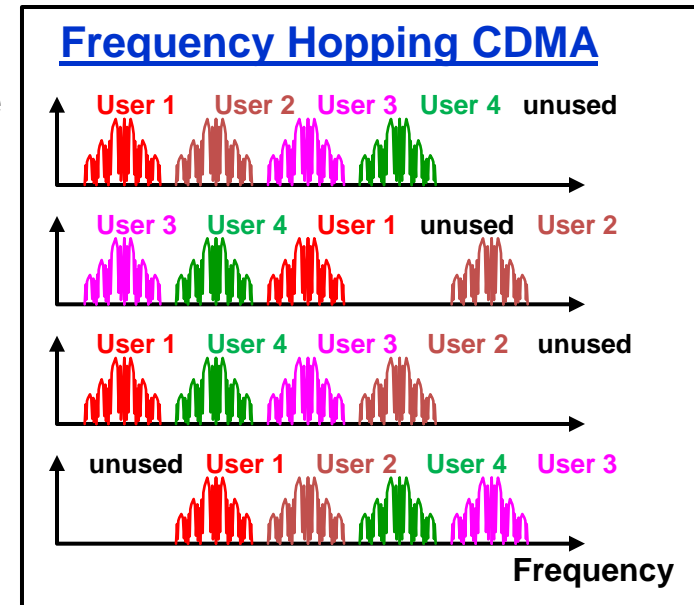

Functional Block Diagram: FHSS

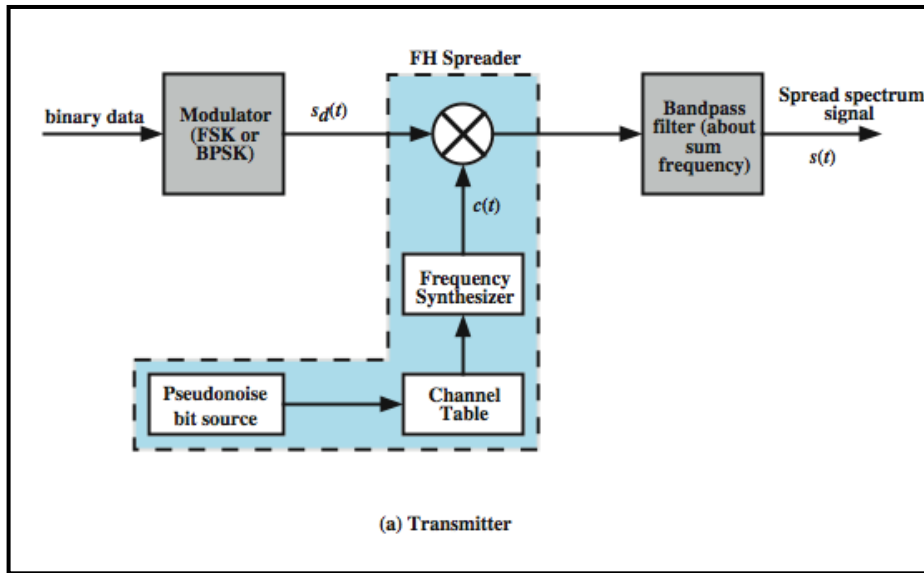

Functional Block Diagram of a Frequency-Hop Spread Spectrum *Transmitter*.

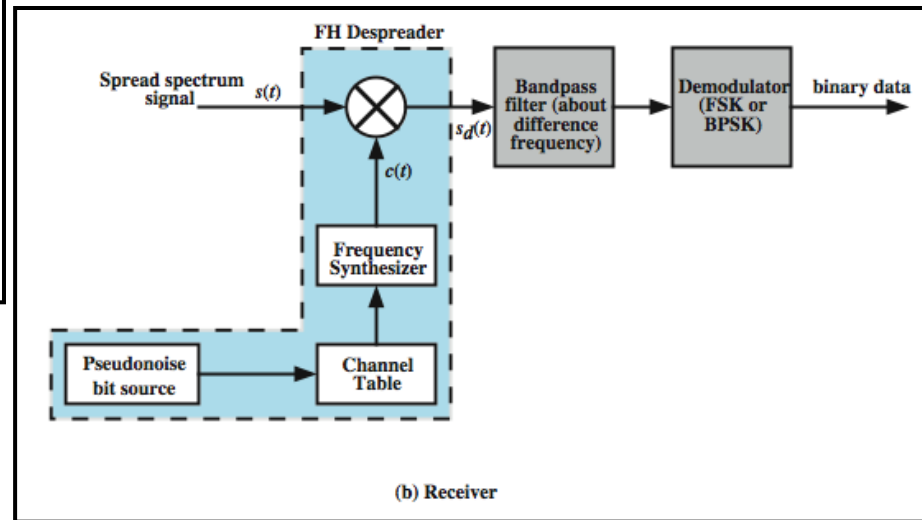

Functional Block Diagram of a Frequency-Hop Spread Spectrum *Receiver*.

CDMA's Pilot Channel

1. A Pilot Channel is transmitted continuously by a central control (e.g.: a base station) and is used by the (mobile) User for initial system acquisition.
2. The same PN sequences are shared by all base stations.
 - A. Each base station is differentiated by a phase offset.
3. Provides tracking of timing reference and phase reference.
4. Separation by phase provides for extremely high reuse within one CDMA channel frequency.
5. Acquisition by mobile stations is enhanced by:
 - A. Short duration of Pilot PN sequence.
 - B. Uncoded nature of pilot signal.
6. Facilitates mobile station-directed handoffs:
 - A. Used to identify handoff candidates.
 - B. Key factor in performing soft handoffs.

DS-CDMA's Processing Gain

Spread spectrum systems reduce the effect of interference due to its processing gain. Processing gain: G_p is the basic figure of merit for spread spectrum systems and is generally defined as follows:

$$G_p = \frac{\text{Spread Spectrum RF Bandwidth}}{\text{Minimum Information Bandwidth}} = \frac{B_{ss}}{B_d}$$

For Direct Sequence, its processing gain is:

$$G_p = \frac{\text{ChipRate}}{\text{DataRate}} = \frac{R_{chip}}{R_b} = \frac{T_b}{T_c}$$

The number of users: N , has a negative effect on the processing gain. Processing gain when the processing loss is taken into account is:

$$G_p = \frac{R_{chip}}{N * R_b}$$

where:

G_p : processing gain.

R_{chip} : Chip rate = $1/T_c$.

R_b : Information data rate = $1/T_b$.

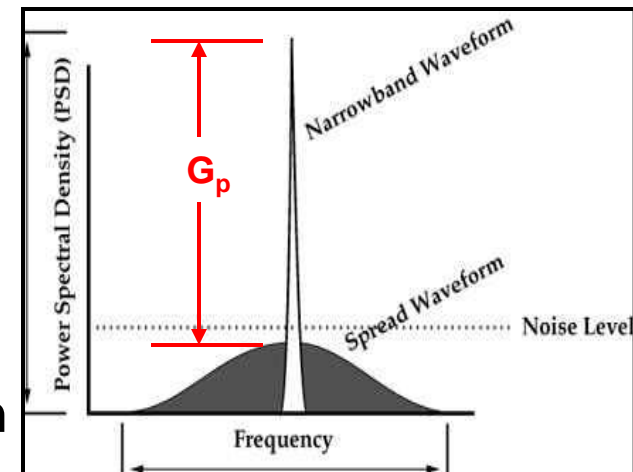

CDMA: Advantages

CDMA *Advantages:*

1. All Users can use the same frequency. No frequency planning/assignment needed. Can exploit the entire bandwidth of the communication system.
2. Huge code space (e.g.: 2^{32}) compared to frequency space.
3. Random access capability: Users can start their transmission at any arbitrary time without worrying about channel saturation.
4. Multipath fading may be substantially reduced because of large signal bandwidth.
5. Privacy: Very challenging for hackers to decipher the PN codeword sent.
 - A. Increased protection against eavesdropping.
6. Anti-jamming: Interference rejection capability. Suitable for military applications.
7. Forward Error Correction (FEC) and encryption can be easily integrated.
8. Capacity degrades gradually with increasing number of users: Noise level at the receiver increases.
9. Low probability of intercept (LPI) and Low Probability of Detection (LPD): The spread signal seems buried in noise and has low power spectral density.
10. No equalizers needed; No guard time needed.

CDMA: Disadvantages

CDMA *Disadvantages*:

1. CDMA is an *interference-limited* system: As the number of users increases, the overall quality of service decreases since RF signals from undesired Users appear as *higher (additive) noise levels* at the receiver.
2. *Self-jamming*: Arises when the spreading sequences of different users are not exactly orthogonal; hence, in the despreading of a particular PN code, non-zero contributions to the receiver decision statistic for a desired user arise from the transmissions of other users in the system.
3. *Near and Far effect*: The *near-far effect* occurs at a CDMA receiver if an *undesired* user transmits a high detected RF power, as compared to the *desired* user, usually because of distance, shadowing and multipath fading. To combat the *near-far effect*, power control is implemented at a central control (e.g: the base station) by rapidly sampling the radio signal strength indicator levels of each (mobile) User, and then sending a power change command (to increase/decrease their transmitted RF power) over the forward radio link. In other words, the nearby transmitters are assigned a lower transmit power level than the far away transmitters.
 - A. Result: Extra hardware complexity to implement power adjustment (Open-loop method or Closed-loop method).

Hybrid Multiple Access Techniques

Some practical systems combine two or more of these multiplexing or multiple access techniques. Hybrid systems are used to overcome the shortcomings of a single Spread Spectrum or multiple access techniques in a given application.

1. **FDMA/CDMA:** Frequency Division Multiple Access CDMA
 - A. Available wideband spectrum is frequency divided into number narrowband radio channels. CDMA is employed inside each channel. Example: IS-95.
2. **DS/FHMA:** Direct Sequence Frequency-Hopped Multiple Access
 - A. The signals are spread using spreading codes (direct sequence signals are obtained), but these signal are not transmitted over a constant carrier frequency; they are transmitted over a frequency-hopping carrier frequency.
3. **TCDMA:** Time Division CDMA:
 - A. Each cell is using a different spreading code (CDMA employed between cells) that is conveyed to the mobile users in its range.
 - B. Inside each cell (inside a CDMA channel), TDMA is employed to multiplex multiple users.
4. **TDFH:** Time Division Frequency Hopping:
 - A. At each time slot, the user is hopped to a new frequency at the start of a new TDMA frame according to a pseudo-random hopping sequence.
 - B. Employed in severe co-interference and multi-path environments.
 - 1) Bluetooth and GSM are using this technique.

Pure CDMA vs. Hybrid CDMA

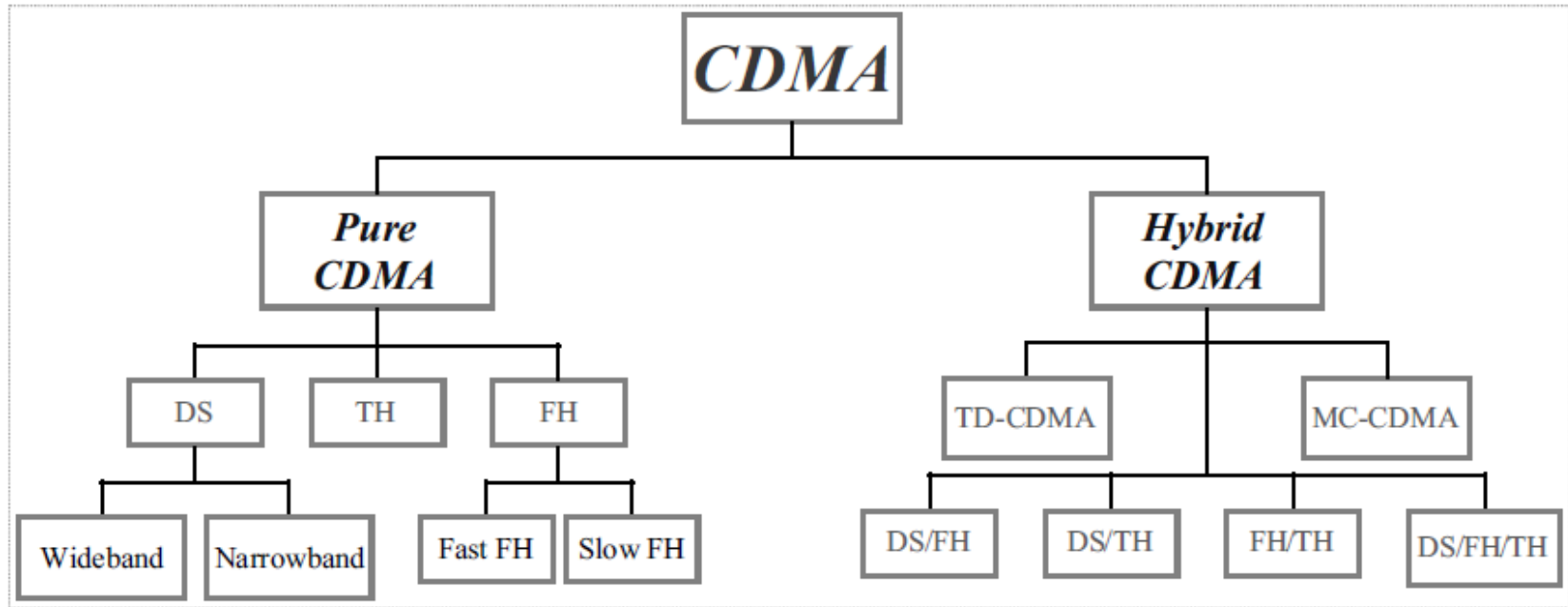

Legend:

DS = Direct Sequence

TH = Time Hopping

FH = Frequency Hopping

TD = Time Division

MC = Multi Carrier

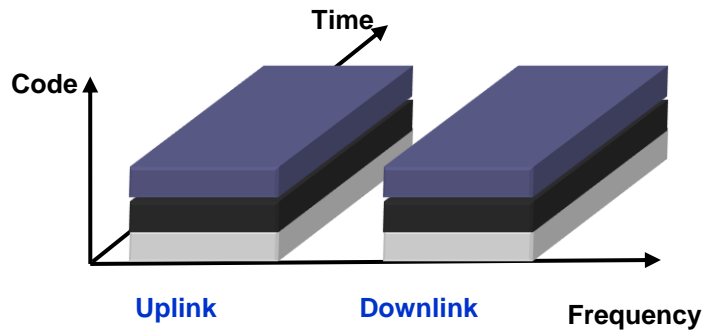

CDMA/FDD

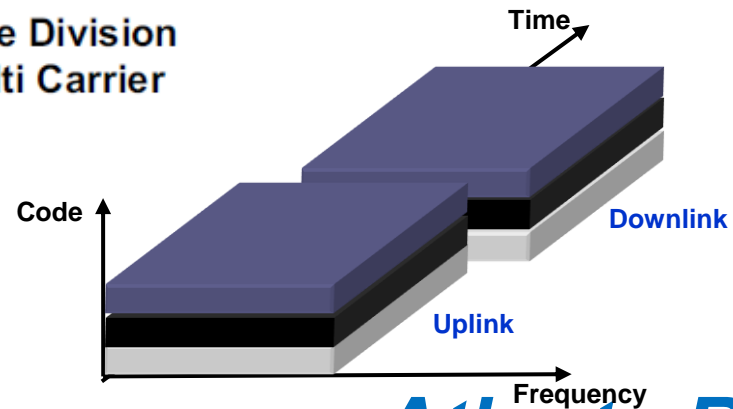

CDMA/TDD

Comparison: SDMA, TDMA, FDMA & CDMA

Approach	SDMA	TDMA	FDMA	CDMA
Idea	Segment space into cells/sectors.	Segment sending time into disjointed time-slots, demand driven or fixed patterns.	Segment the frequency band into disjoint sub-bands.	Spread the spectrum using orthogonal codes.
Terminals	Only one terminal can be active in one cell/one sector.	All terminals are active for short periods of time on the same frequency	Every terminal has its own frequency, uninterrupted.	All terminals can be active at the same place at the same moment, uninterrupted.
Signal separation	Cell structure, directed antennas.	Synchronization in the time domain.	Filtering in the frequency domain.	Code plus special receivers.
Advantages	Very simple, increases capacity per km ² .	Established, fully digital, flexible.	Simple, established, robust.	Flexible, less frequency planning needed, soft handover.
Dis-advantages	Inflexible; antennas typically fixed.	Guard space needed (multipath propagation); synchronization difficult.	Inflexible; frequencies are a scarce resource.	Complex receivers, needs more complicated power control for senders.
Comment	Only useful when combined with TDMA, FDMA or CDMA.	Standard in fixed networks, together with FDMA/SDMA used in many mobile networks.	Typically combined with TDMA (frequency hopping patterns) and SDMA (frequency reuse).	Still faces some problems, higher complexity, lowered expectations; will be integrated with TDMA/FDMA.

Comparison of FDMA, TDMA & CDMA

Feature	FDMA	TDMA	CDMA
High carrier frequency stability	Required	Not necessary	Not necessary
Timing/synchronization	Not required	Required	Required
Near-to-Far effect	No	No	Yes, Power control techniques.
Variable transmission rate	Difficult	Easy	Easy
Fading mitigation	Equalizer not needed	Equalizer may be needed	RAKE receiver possible
Power monitoring	Difficult	Easy	Easy
Zone size	Any size	Any size	Large size difficult

Multiple Access/Duplex in Cellular Systems

Cellular System	Multiple Access/ Duplex Technique
AMPS: Advanced Mobile Phone System	FDMA/FDD
GSM: Global System for Mobile	TDMA/FDD
US Digital Cellular: USDC (IS-54 and IS-136)	TDMA/FDD
PDC	TDMA/FDD
CT2 Cordless Phone	FDMA/TDD
DECT: Digital European Cordless Telephone	FDMA/TDD
IS-95: US Narrowband Spread Spectrum	CDMA/FDD
W-CDMA	CDMA/FDD CDMA/TDD
cdma2000	CDMA/FDD CDMA/TDD

Summary: Multiple Access Techniques

Digital Communications

FDMA

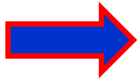

Advantages of Frequency Division Multiple Access:

1. Network timing not required.

Disadvantages:

1. Intermodulation noise reduces the usable output Power, hence there is a loss of capacity, relative to single carrier capacity.
2. Uplink control power required.
3. The frequency allocation may be difficult to modify.

TDMA

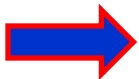

Advantages of Time Division Multiple Access:

1. Maximum use of satellite transponder; higher throughput compared to FDMA when the number of accesses is large.
2. Uplink power control not needed.
3. No mutual interference between accesses.
4. Digital circuitry has decreasing cost.

Disadvantages:

1. Network control (timing) required.
2. Stations transmit high bit rate bursts requiring large peak power.

CDMA

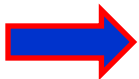

Advantages of Code Division Multiple Access:

1. Anti-jamming capability.
2. Network timing not required.

Disadvantages:

1. Wide bandwidth per user required.
2. Precision code synchronization needed.

Atlanta RF



Atlanta RF

Services, Software & Designs



Bob Garvey
Chief Engineer
Atlanta RF, LLC

Thank You!

Contact Atlanta RF by e-mail at:

- Atlanta RF *Services* : Services@AtlantaRF.com
- Atlanta RF *Software* : Sales@AtlantaRF.com
- Atlanta RF *Designs* : Designs@AtlantaRF.com

Or, contact Atlanta RF by phone at: 678-445-5544, to reach our Atlanta-area office in Georgia, USA, and discuss our support to your current or future projects & products.

Atlanta RF

Services, Software & Designs

Presentations by Atlanta RF, LLC

Download various presentations at our website: www.AtlantaRF.com :

1. Satellite: LEO, MEO & GEO.
2. Antennas: An Overview.
3. Link Budget: Getting Started.
4. Link Budget: Digital Modulation Part 1 (Overview & M-ASK).
5. Link Budget: Digital Modulation Part 2 (M-FSK).
6. Link Budget: Digital Modulation Part 3 (M-PSK & QAM).
7. Link Budget: Error Control & Detection.
8. Multiple Access Techniques: FDMA, TDMA and CDMA.
9. Insertion Loss: Double Ridge Waveguide.
10. RF Filters: An Overview.

Visit our website often as presentations are added for your viewing pleasure.